



**Phihong Midspan POE GUI
User Manual
SNMP v3, v2, v1 Rev. 1.0
PES12780**

Compliant Models:

POE125U-8N

POE370U-480-8N

POE370U-480-16N

POE360U-480-24N

POE576U-8ATN

POE576U-16ATN

POE576U-24AFATN



Disclaimer

Phihong accepts no accountability or liability arising from the use of the Midspans, as described in this document. The handling of equipment will be users' responsibility. Applications described in this document are for descriptive purposes only. Phihong does not provide warranty on modified products.

Notice

This document contains information about the software and hardware used on the Midspan. The information is held to be accurate and reliable from time of print. Please be advised that product development and revisions are still in course of action. Phihong cannot be held responsible for involuntary error, exclusions, inaccuracies, or following changes of printed material.

Phihong reserves the right to make changes to products and to their specifications as described in this document, at any time, without prior notice. The contents of this document may not be photocopied or reproduced in any form without written permission of Phihong.

NOTE: Midspans are for indoor use only!

© August 2009 Phihong USA Corp.
All Rights Reserved.

This document is subject to change without notice.



Contents

1. Safety Procedures	
1.1. General Precautions	6
2. Midspan Hardware Setup	
2.1. Physical Hardware Appearance	8
2.2. Power Cord Requirements	9
2.3. Connecting Ethernet Cables	10
2.4. Connecting USB and Power Cables	10
2.5. Powering Up	11
2.6. LED Indicators	11
2.7. Rack-Mounting Installation	12
2.8. Technical Specifications	13
3. Phihong GUI and USB Driver Installation	
3.1. PC-to-Midspan Connection via USB/RS232	15
3.2. Device Manager: To View Port Properties	16
3.3. USB Block Diagram	18
4. Midspan GUI	
4.1. GUI Main Window	19
4.2. GUI System Control and Information	20
4.3. GUI Port Description	22
4.4. GUI Parametric Information	24
5. Midspan Troubleshooting	25
6. Appendix	
A. Optional RPS – option R	26
B. Optional NIC Interface – option N	
1. Interface Setup	27
2. Advanced Setup Options	29
3. Controller Setup	30
3.1. System Administration	31
3.2. SNMP Settings	35
4. DHCP Client – Dynamic and Static Mode Setup	37
5. Setup NIC Midspan with Phihong GUI	39
C. SNMP MIB Controls	41
D. Frequently Asked Questions	47



List of Figures:

Figure 1 – Midspan is not connected	8
Figure 2 – Data & Power (top row), Data (bottom row)	8
Figure 3 – Connectors and Indicator	8
Figure 4 – Rear Side of Midspan	8
Figure 5 – DC Power Connector	8
Figure 6 – AC Power Connector	8
Figure 7 – Midspan connected through ‘Data & Power’ line	10
Figure 8 – NIC Cable	10
Figure 9 – USB Cable	10
Figure 10 – USB Cable Connected	10
Figure 11 – AC Power Cord	10
Figure 12 – Rack-Mounted Midspan	12
Figure 13 – Rack Mounting Bracket and Screws	12
Figure 14 – Technical Specifications	13
Figure 15 – GUI Setup	15
Figure 16 – Device Manager	15
Figure 17 – PC-to-Midspan Connection via USB/RS232	16
Figure 18 – Prolific USB-to-Serial Com Port General Properties	17
Figure 19 – Prolific USB-to-Serial Com Port Advanced Properties	17
Figure 20 – USB Block Diagram	18
Figure 21 – GUI Main Window	19
Figure 22 – GUI Connection Information	19
Figure 23 – System Setup, Control, System Information and Port Commands	20
Figure 24 – System Update	21
Figure 25 – Port Description	22
Figure 26 – LED Key (Port Status)	23
Figure 27 – Parametric Information	24
Figure 28 – DC Power Connector	26



Figure 29 – PC-to-Network-to-Midspan	27
Figure 30 – Ethernet Manger	28
Figure 31 – Controller Login	29
Figure 32 – Controller Main Window	30
Figure 33 – Controller System Administration	31
Figure 34 – Controller Firmware Backup	33
Figure 35 – Controller Firmware Update	33
Figure 36 – Controller SNMP Settings	35
Figure 37 – GUI Connection Information (USB)	36
Figure 38 – GUI User Security Parameters	36
Figure 39 – Ethernet Manager Set IP Address	37
Figure 40 – Local Area Connection Status	38
Figure 41 – Local Area Connection Properties/Internet Protocol Properties	38
Figure 42 – GUI User Security Parameters	39
Figure 43 – GUI User Security Parameters/Ethernet Manager	39
Figure 44 – GUI Connection Information (SNMP)	40
Figure 45 – GUI Main Window	40
Figure 46 – Network Domain Diagram	45

List of Tables:

Table 1: LED Indicator	12
Table 2: Electrical Specifications	14
Table 3: Troubleshooting	25
Table 4: DC Specifications	26
Table 5: Controller Setup	32
Table 6: SNMP Settings	35
Table 7: SNMP MIB Controls	41



1. Safety Procedures

1.1. General Precautions

General – Please read the following precautions carefully before installing and connecting the system to a power source.

Note – Only qualified and trained service personnel (in accordance with IEC 60950 and AS/NZS 3260) should install, replace, or service the equipment. Install the system in accordance with Country, National or to the U.S. National Electric Code if you are in the United States.

Precautions:

1. The building facilities in which the product will be used requires a fuse or circuit breaker no larger than 15A for 120Vac (U.S.A.) or 10A, 230Vac (international). The building facilities must protect the Midspan from over current or short-circuits.
2. Before connecting the Midspan to a power source (including power cord requirements), read the Midspan Hardware Setup procedure in Section 2. This procedure as with all procedures and instructions can be found in the Midspan User Manual. To download a copy of the Manual, visit www.phihong.com.
3. To prevent the Midspan from overheating, do not operate the product in an area that exceeds the maximum recommended ambient temperature of 40oC. Allow at least 3 to 4 inches of clearance around all ventilation openings.
4. In order to Support the Midspan weight, do not stack the chassis on any other equipment. Shelf mounted equipment requires a stable and durable surface. When installed, do not push or pull on the Midspan when the equipment is installed.
5. The Midspan consists of two rows of “Data” and “Data & Power” ports. The ports use RJ-45 data sockets. Do not connect telephone cables into these ports. Only RJ-45 data cables may be connect to these sockets.
6. Do not work on the Midspan system or connect or disconnect the cables, during periods of lightning activity.
7. The AC or DC plus/socket combination must be accessible at all times, as it serves as the main disconnect device to the product.
8. Before servicing the product, always disconnect the products from its AC and DC source.
9. Disposal of this product should abide by all appropriate National laws and regulations.



1.1 Sicherheitsmaßnahmen – Allgemeine Vorsichtsmaßnahmen

Allgemein – Lesen Sie die folgenden Vorsichtsmaßnahmen sorgfältig durch, bevor Sie das System installieren und an eine Energiequelle anschließen.

Hinweis – Das Gerät darf nur durch qualifiziertes und geschultes technisches Personal (gemäß IEC 60950 [Vorschrift 60950 der Internationalen Elektrischen Kommission] und AS/NZS 3260 [Vorschrift für Australien und Neuseeland]) installiert, ersetzt oder repariert werden. Installieren Sie das System auch in Übereinstimmung mit den geltenden nationalen oder europäischen Vorschriften bzw. Der NEC-Vorschrift, falls Sie sich in den Vereinigten Staaten befinden.

Vorsichtsmaßnahmen:

1. Die Gebäudeinstallationen, in denen das Produkt benutzt wird, müssen über eine Sicherung oder einen Schutzschalter mit maximal 15A für 120 Vac (USA) oder 10A für 230Vac (international) verfügen. Die Gebäudeinstallationen müssen das Midspan-Device vor zu starkem Strom oder Kurzschlüssen schützen.
2. Lesen Sie vor dem Anschließen des Midspan-Device an eine Energiequelle (einschließlich der erforderlichen Anschlussleitungen) die Setup-Anleitung für Ihre Midspan-Hardware in Kapitel 2 genau durch. Dieses Verfahren wird zusammen mit allen weiteren Vorgängen und Anweisungen im Benutzerhandbuch für das Midspan-Device beschrieben. Sie können das Benutzerhandbuch unter www.phihong.com herunterladen.
3. Um das Midspan-Device vor Überhitzung zu schützen, benutzen Sie das Produkt nicht in Räumen, die die maximale empfohlene Umgebungstemperatur von 40°C überschreiten. Lassen Sie um alle Lüftungsöffnungen herum mindestens 7,5 bis 10 cm (3-4 inches) frei.
4. Stützen Sie das Gewicht des PoE Midspan-Device nicht ab, indem Sie das Gehäuse auf ein anderes Gerät stellen. Falls Sie das Gerät auf ein Gestell montieren, muss dieses eine stabile und haltbare Oberfläche haben. Nach der Installation des Systems bewegen Sie das Midspan-Device nicht mehr.
5. Das Midspan-Device enthält zwei Reihen mit "Datenports" und "Daten-und-Stromports." Die Ports verwenden RJ45-Datenanschlüsse. Schließen Sie keine Kabel an und trennen Sie keine Kabelverbindungen während Gewittern mit Blitzen.
6. Führen Sie an dem Midspan-System keine Arbeiten durch, schließen Sie keine Kabel an und trennen Sie keine Kabelverbindungen während Gewittern mit Blitzen.
7. Der Steckanschluss für Gleich- oder Wechselstrom muss jederzeit zugänglich sein, da er als Haupttrenngerät für das Produkt dient.
8. Trennen Sie das Produkt immer erst von der Stromquelle, bevor Sie Wartungs- oder reparaturarbeiten daran durchführen.
9. Entsorgen Sie dieses Produkt gemäß aller geltenden Gesetze und Vorschriften Ihres Landes und der EU (falls Sie sich in einem Land der EU befinden).

2. Midspan Hardware Setup

2.1 Physical Hardware Appearance:

Front Side of the Midspan:



Figure 1: The Midspan is not Connected

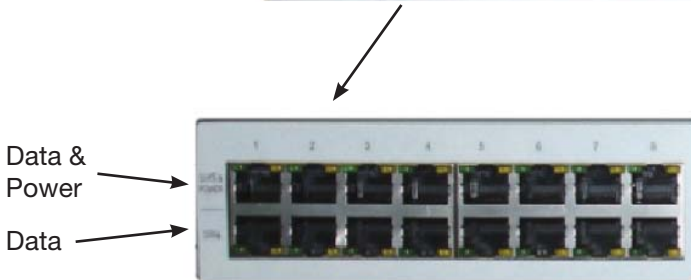

Figure 2: Data & Power (top row), Data (bottom row)

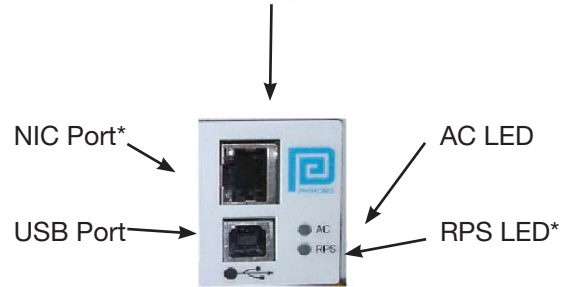

Figure 3: Connectors and Indicators

Rear Side of the Midspan:

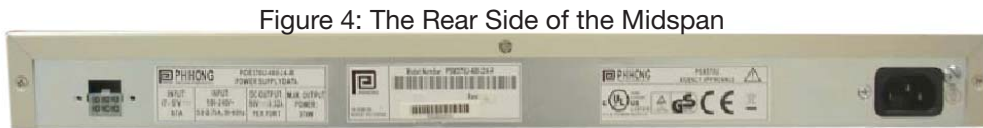

Figure 4: The Rear Side of the Midspan

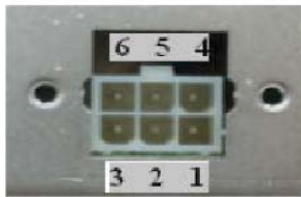

Figure 5: DC Power Connector*

Pin	Description
1	+47VDC to +57VDC
2	Current Share
3	-47VDC to -57VDC
4	+47VDC to +57VDC
5	Not Used
6	-47VDC to -57VDC



Figure 6: AC Input Connector
AC IN: IEC320 inlet 3 pin

DC IN: Molex, 6 pin p/n 39-30-0060 or equivalent

DC IN Mate: Molex, 39-01-2065, pin p/n 39-00-0077

* Optional Components - please see appendices A and B



2.4 Powering Your Midspan

Power Cord Requirements

Power cords must meet the requirements for the country it is intended to be used.

U.S.A and Canada

- The cord must have a minimum of 10A rated current competence
- The cord must be CSA or UL approved
- The minimum requirement for the flexible cord is:
 - o 18 AWG (10A)
 - o Three-Conductor (Line, Neutral, Ground)
 - o Type SV (stranded Vacuum Rubber Jacketed) or SJ (stranded Junior Rubber Jacketed) or SVT (Stranded Vacuum Rubber Jacketed Thermoplastic) or SJT (Stranded Junior Thermoplastic)
- The plug must be earth-grounded with a NEMA 5-15 (15A, 125V) or NEMA 6-15P (15A, 250V) configuration

Europe

Switzerland

- The supply plug must comply with SEV/ASE 1011

Denmark

- The supply plug must comply with section 108-2-D1, standard DK2-1a or DK2-5a

United Kingdom

- The Midspan is covered by General Approval (section 16.16.060, NS/G/12345/J100003, for indirect connection to a public telecommunication system)

France and Peru

- IT equipments cannot power this device. In the case of an IT powered device, the unit needs to be powered by 230V through an isolation transformer with a ratio of 1:1 and the secondary connection (Neutral) is properly grounded
- The Midspan must have access to a nearby power outlet. By disconnecting the power cord from the outlet, you will eliminate power from the device.
- The flexible cord that connects to the Midspan must have a configuration to connect with an EN60320/IEC320 inlet connector.
- According to the EN60950/IEC 950 specifications this device functions under SELV (Safety Extra Low Voltage) conditions. The conditions are true if the equipment and the connected device functions under SELV conditions.

2.3 Connecting Ethernet Cables*



Figure 7: POE370U-480-24N connected through 'data & power' line



Figure 8: NIC Cable Connected*

2.4 Connecting USB and Power Cables

USB cable:

The USB cable is connected to the USB connector located in the front side of the Midspan and a USB port on your PC/laptop.



Figure 9: USB Cable*



Figure 10: USB Cable Connected

AC power cord:

The AC power cable is connected to the AC power connector located in the rear side of the Midspan and the power outlet.



Figure 11: AC Power Cord**

*Ethernet and USB cables are not included

**AC power cord may be ordered separately



2.5 Powering UP

Midspan receives power via the power cord. In order to apply or remove power to/from the Midspan connect or disconnect the AC power cable to/from the AC power connector on the rear side of the unit.

With AC power applied, the unit starts-up and the internal fans are active. The device runs through a quick power-on test, which takes less than 10 seconds. During this period, all ports are initially disabled and the port indicators light up. The sequence of the port LEDs are shown in section 2.6 LED Indicator – Cold Start. Ports are now operating under normal conditions.

2.6 LED Indicator:

Cold Start:

- a. AC – LED turns ‘green’ » remains on
- b. NIC – LED turns ‘green’ » red » green » turns off » red » turns off (unless connected)
- c. 24-Ports (with ports connected) – LED turns ‘orange’ » green » orange » green » turns off – LED turns ‘green individually » ports 1,9,17 » ports 2,10,18 » ports 3,11,19 » ports 4,12,20 » ports 5,13,21 » ports 6,14,22 » ports 7,15,23 » ports 8,16,24 » All 24-Ports are connected – LED remains ‘green’
- d. 24-Ports (without ports connected) – LED turns ‘orange’ » green » orange » green » turns off – LED blinks ‘orange individually » ports 1,9,17 » ports 2,10,18 » ports 3,11,19 » ports 4,12,20 » ports 5,13,21 » ports 6,14,22 » ports 7,15,23 » ports 8,16,24 » Blinks ‘orange’ across all 24-Ports

When ‘System Reset’ is clicked on the GUI (applications file):

- a. AC – LED remains ‘green’
- b. NIC – LED remains off until the unit is connected
- c. 24-Ports (with ports connected) – same sequence as Cold Start
- d. 24-Ports (without ports connected) – same sequence as Cold Start



Table 1: LED Indicator

Indicator	Conditions			
	LED Off	Green	Orange	Blinking Orange
Port LED	Indicates port is disabled	Indicates port is connected	Indicates port has an error	Indicates port is disconnected but enabled
NIC LED	Indicates NIC is disconnected from Network	N/A	Indicates NIC is connected to Network	N/A
AC LED	Indicates Midspan is not powered	Indicates Midspan is powered	N/A	N/A

2.7 Rack-Mounting Installation



Figure 12: Rack Mounted Midspan (Front)



Figure 13: Rack Mounting Bracket and screws (side/rear)

Position the Midspan on the rack. Arrange the mounting bracket to the corresponding screw holes on the Midspan. Keep the screw area visible to insert screws, and then tighten the screws. Screws and brackets will be included in the package.



2.7 Technical Specifications

Figure 14: Technical Specifications

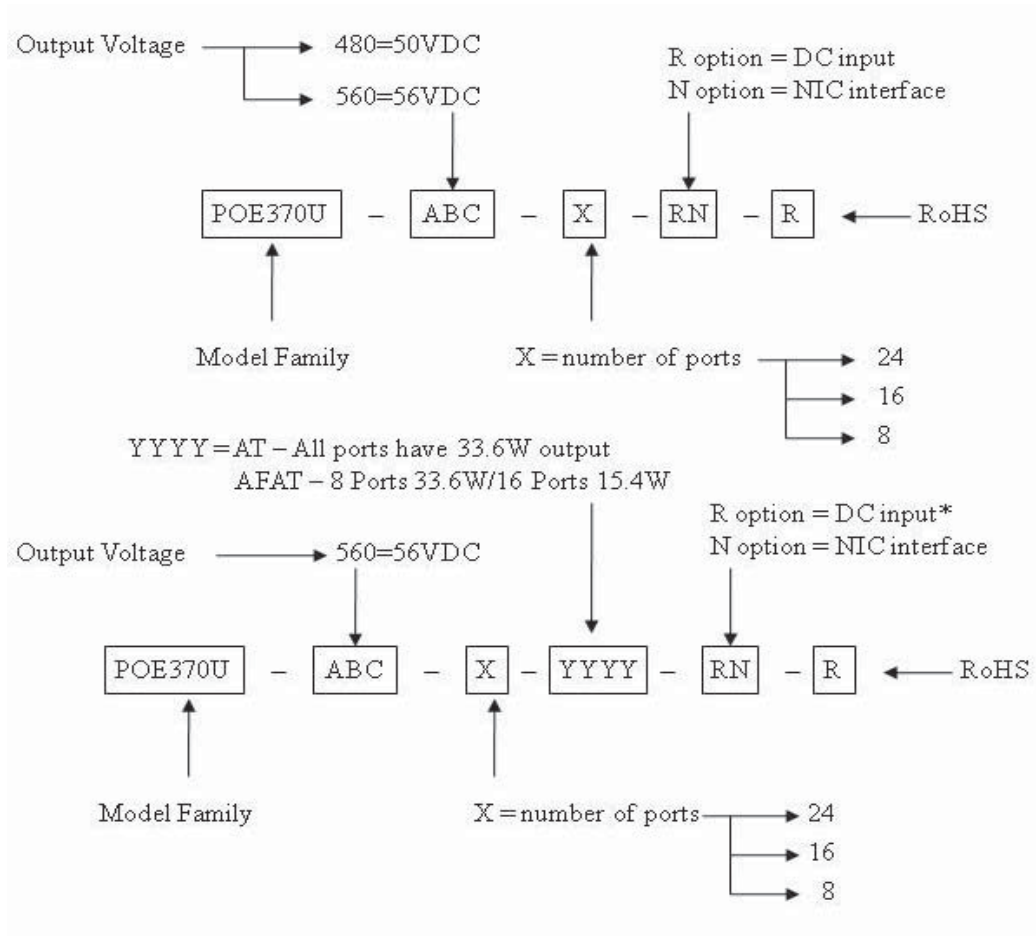

Mechanical Specifications:

Dimensions - 17.25 inch (438 mm) length
8.98 inch (228 mm) width
1.75 inch (44.5 mm) height

Environmental Specifications:

Temperature

- Operating: 0°C to +40°C
- Non-Operating: -25°C to +65°C

Relative Humidity

- Operating: 5 to 90%
- Non-Operating: 5 to 90%

*Contact Phihong Sales for this option



Electrical Specifications:

Table 2: Electrical Specifications

Parameters	Specifications		
AC Input Voltage Rating	100V AC to 240V AC		
AC Input Voltage Range	90V AC to 264V AC		
AC Input Current	5.5A (RMS) at Max Load		
AC Input Frequency	47Hz to 63Hz		
Max. In-Rush Current	30A for 115V AC at Max. Load 60A for 230V AC at Max. Load		
DC Input Voltage Range (-R Option)	47V DC to 57V DC		
DC Input Current	8.7A Max.		
AC Output Voltage	POE370U		POE576U
	-480	-560	-560
	50VDC	56V DC	56V DC
Max Load Current	0.32A	0.275A	0.65A
Output Power, per Port			
POE370U	15.4W (not to exceed total output power)		
POE576U-AT	33.6W (not to exceed total output power)		
POE576U-AFAT	Ports 1-8: 33.6W / Ports 9-24: 15.4W (not to exceed total output power)		
Total Output Power	No. of Ports		
	-8	-16	-24
POE370U	125W max	250W max	370W max
POE576U-AT	268W max	537W max	N/A
POE576U-AFAT	N/A	N/A	515W
Nominal Output Voltage	44V DC to 57V DC		



3. Pihong GUI and USB Driver Installation:

Please locate and download the file **Pihong GUI Installation** from the support section of the Pihong websites: www.midspans.com or www.phihong.com.

Please follow the Installation Wizard to install the Pihong GUI for your model, and the USB-to-Serial Com Port driver. The USB-to-Serial Com Port driver is necessary for communicating between the Midspan via a Communication Port on the PC.



Example of the Setup File

Figure 15: GUI Setup



Note: Please refer to the Pihong website to insure you are installing the latest version of the Pihong GUI. The example shown is using the Midspan POE GUI.

3.1 PC-to-Midspan Connection via USB/RS232

Figure 16: PC-to-Midspan Connection Diagram

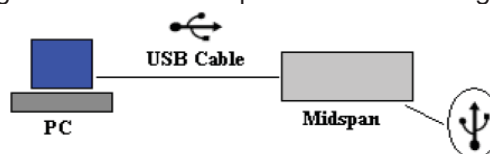

3.2 Device Manager: to view Port Properties

When you are ready to begin, please connect the proper end of the USB-to-Serial cable to your Midspan and the other to an available USB port on your PC. If you installed the USB driver described above, your PC will locate the new hardware.

To view which Serial COM Port your Midspan is installed please follow the instructions:

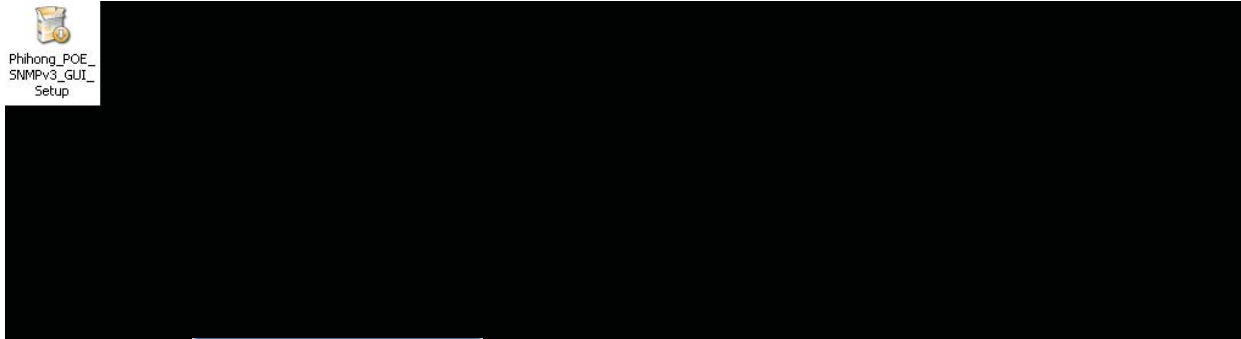

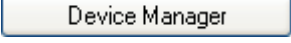
Please click  , the following window will open:

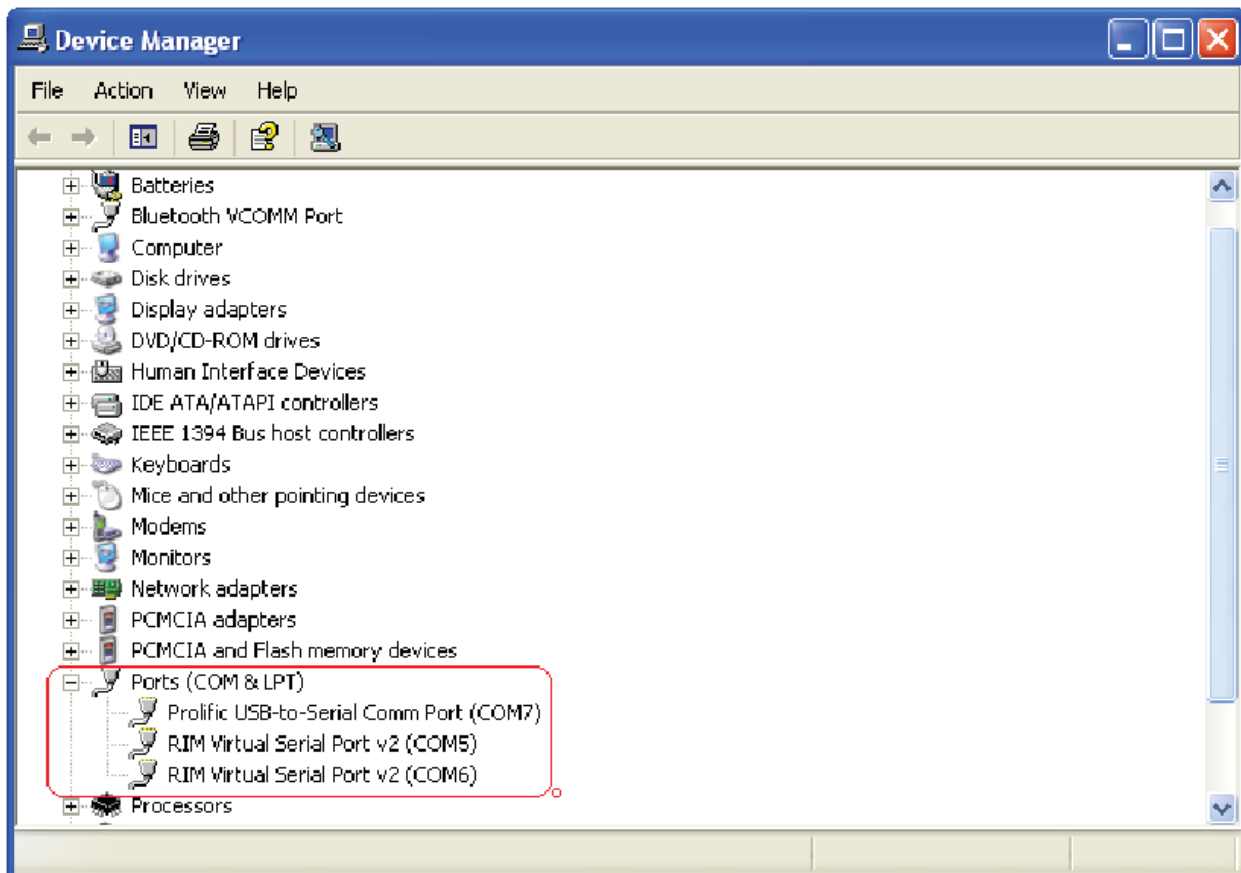

Figure 17: Device Manager

Locate and Expand 'Ports (COM & LPT)'



Double Click the  Prolific USB-to-Serial Comm Port (COM7) . In this example the USB-to-Serial Comm port is installed on Com1. The Com port will vary upon user.



Figure 18: Prolific USB-to Serial Com Port Properties/General Settings

Click . Assure Port Setting is as shown. Click . Click the pull down menu and select the Com Port Number or stay with the default.

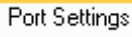
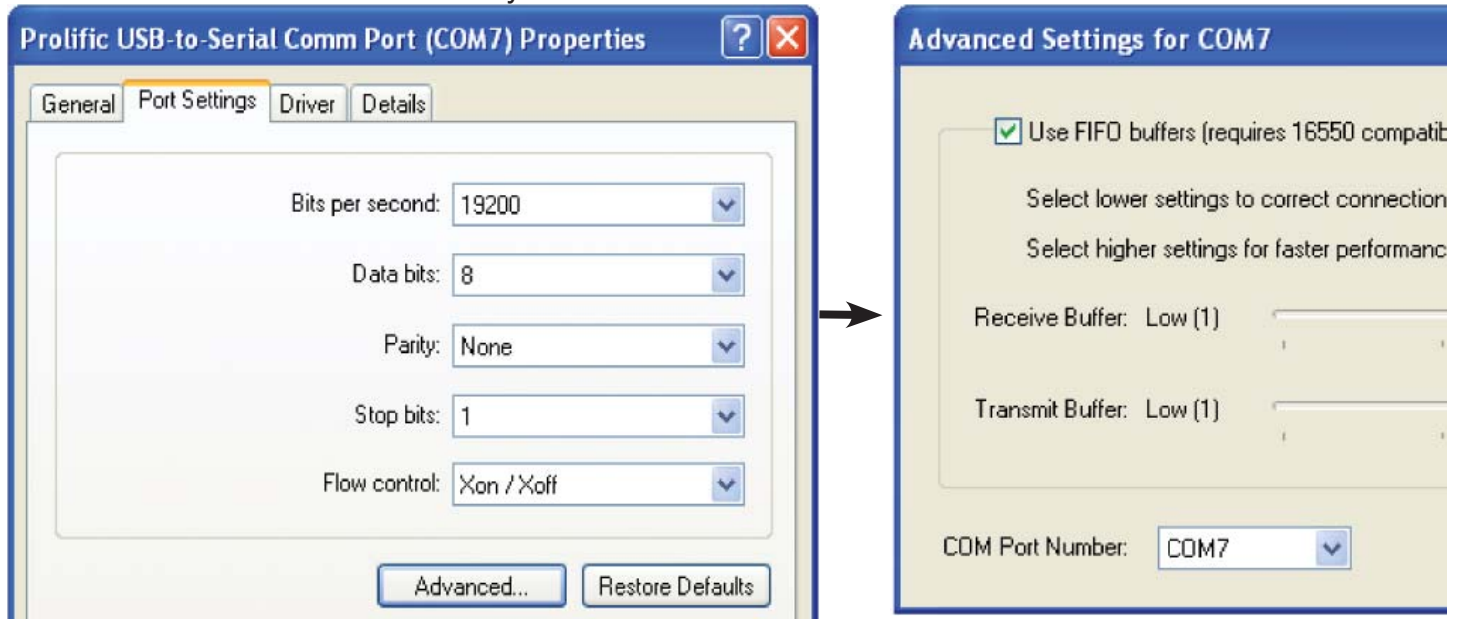



Figure 19: Prolific USB-to Serial Com Port Properties/Advanced Settings

Click  to save all changes.

Notes: Users should write down the Com Port number as the GUI will need to know the exact port on which to search for devices.

3.3 USB Block Diagram

Figure 20: USB Block Diagram

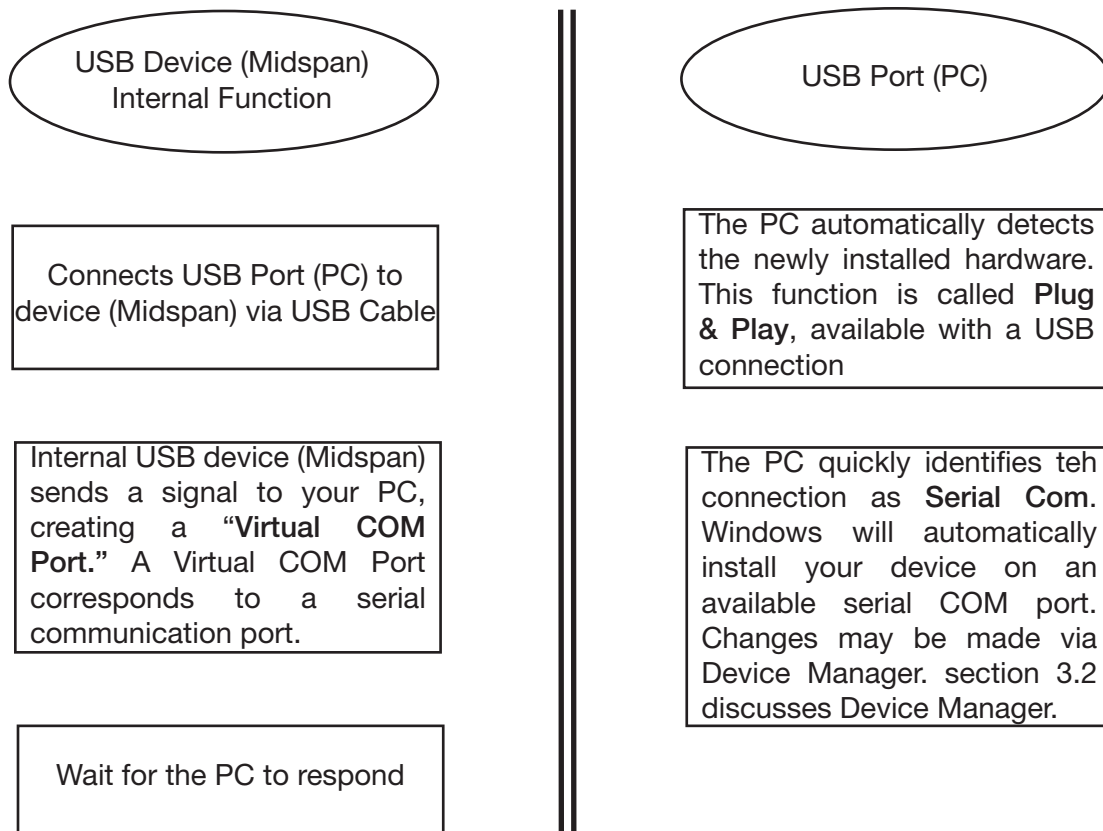

Note: Assume USB-to-Serial-Com Port driver is installed. Users' PC will automatically detect the newly installed/connected hardware.



4. Midspan GUI

The firmware is supplied with a Graphical User Interface (GUI), which is used to configure and manage the PoE midspan system. If you have successfully installed the Pihong GUI and USB driver – Please locate the Pihong Midspan POE GUI on your desktop or from your Start Menu.



4.1 GUI Main Window

Step 1: Choose connection type

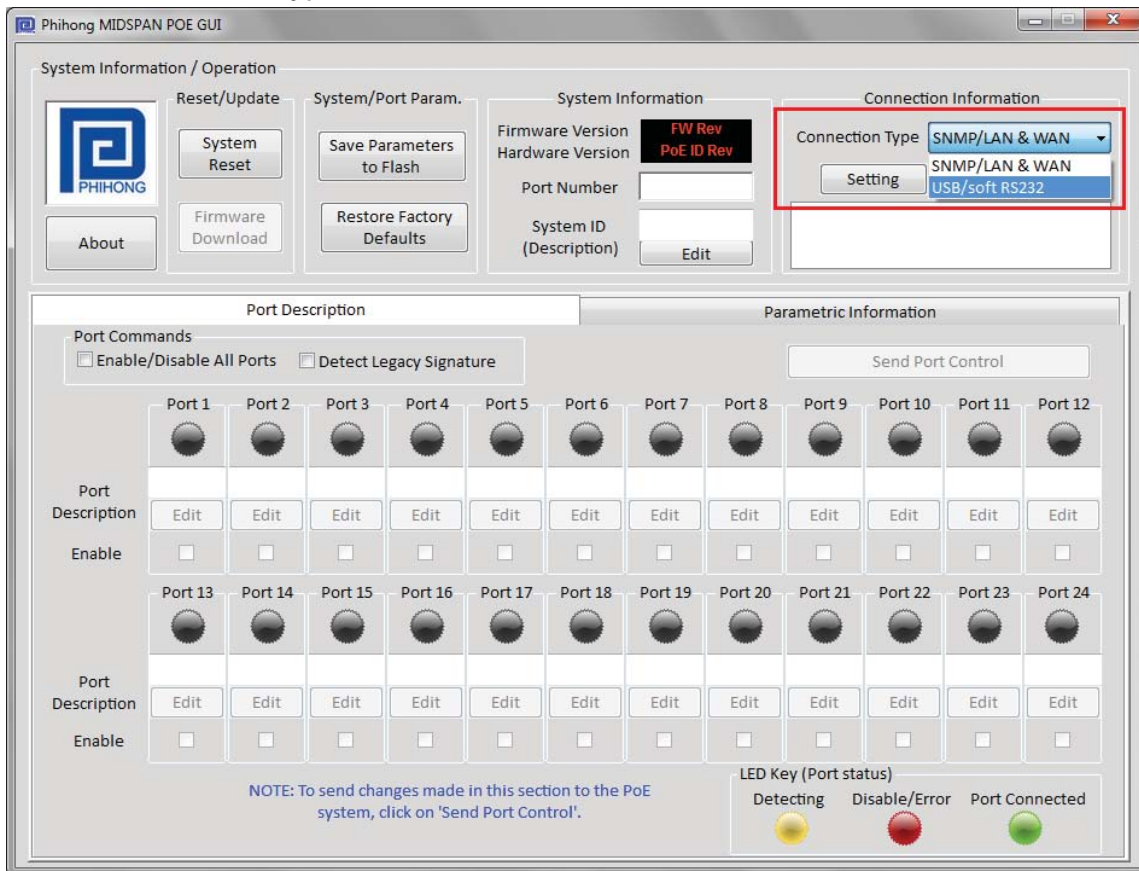

Figure 21: GUI Main Window

Step 2: Select Com Port number then press Search POE and highlight the midspan

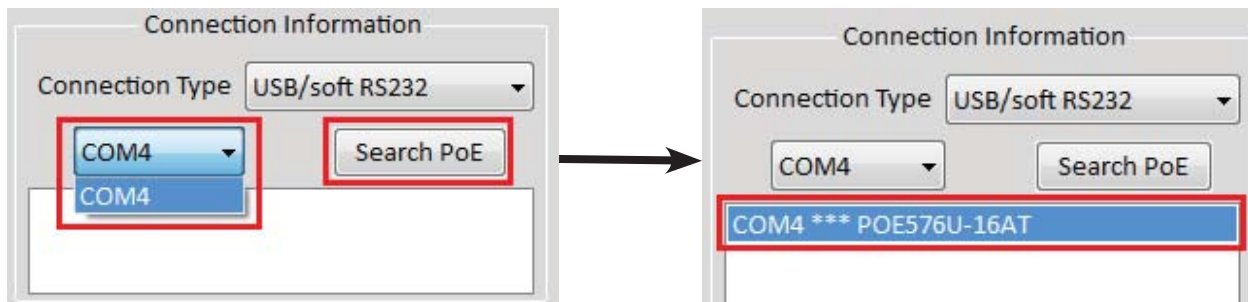
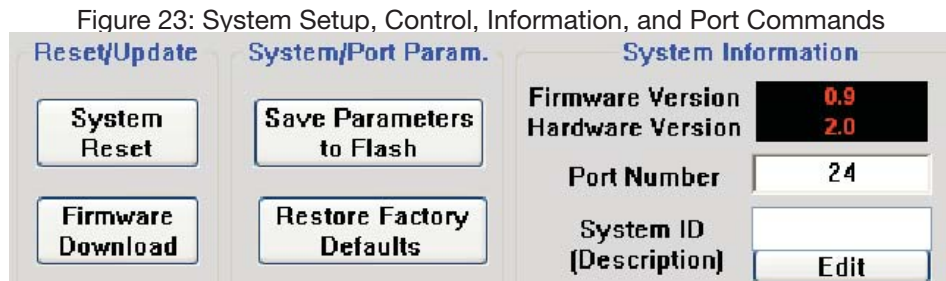

Figure 22: GUI Connection Information

4.2 GUI System Control and Information:

The System Control and Information panel on the GUI supports the main system level parameters for the μ P. It also displays information about the PoE ID, firmware revision and system status.



The system level parameters that can be configured are:

- *System Reset* – This is a function that allows the GUI to reset the software on the μ P. (If System Reset is set and the GUI does not respond, user must click “Reset GUI”)
- *Firmware Download* – This feature is used to download new application/firmware codes onto the μ P. Please refer to the Pihong website www.midspans.com for the latest firmware for your midspan – POE Firmware.

Note: Please allow the GUI a few seconds to respond to the commands selected. DO NOT click or check any commands simultaneously. If a command is selected more than once within two seconds, the GUI may not respond properly.

The “Save Parameters to Flash” button will save system and port parameters to flash memory, so that they can be used to the firmware across reboots of the μ P.

The “Restore Factory Defaults” button will reset the defaults in the firmware, and clear any stored data in the flash memory, the device will reset automatically. After the device has successfully reset, the “System Status” will read “0.” Click “Reset GUI” if necessary. **To make the factory defaults permanent, the user must click “Save Parameters to Flash.”**

The System ID field specifies the hardware revision of the PoE device. The firmware version is represented in a major/minor format.

System ID/Name – click “Edit” to edit/change the description of the system. If you click “Cancel”, the previous description will be set for the system. **To make this permanent the user must click “Save Parameters to Flash.”**



During the 'Download In Progress', the GUI function buttons will be temporarily disabled.

Figure 24: System Update

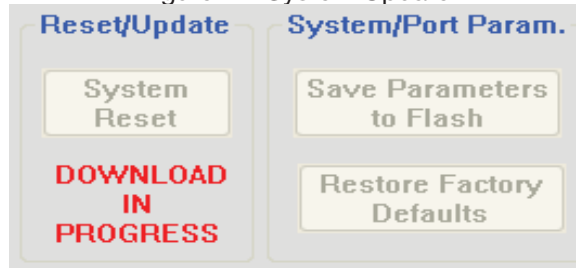

Example of GUI firmware file:

 PoE576FirmwareV09_051509.s99

73 KB 599 File

5/15/2009 9:01 AM

4.3 GUI Port Description:

The Port Description panel shows 24-ports. On the PoE Midspans that have 8 or 16-ports, the port numbers higher than the system port count will be shaded grey and disabled. Each section specifies the individual port descriptions for the system.

Figure 25: Port Description

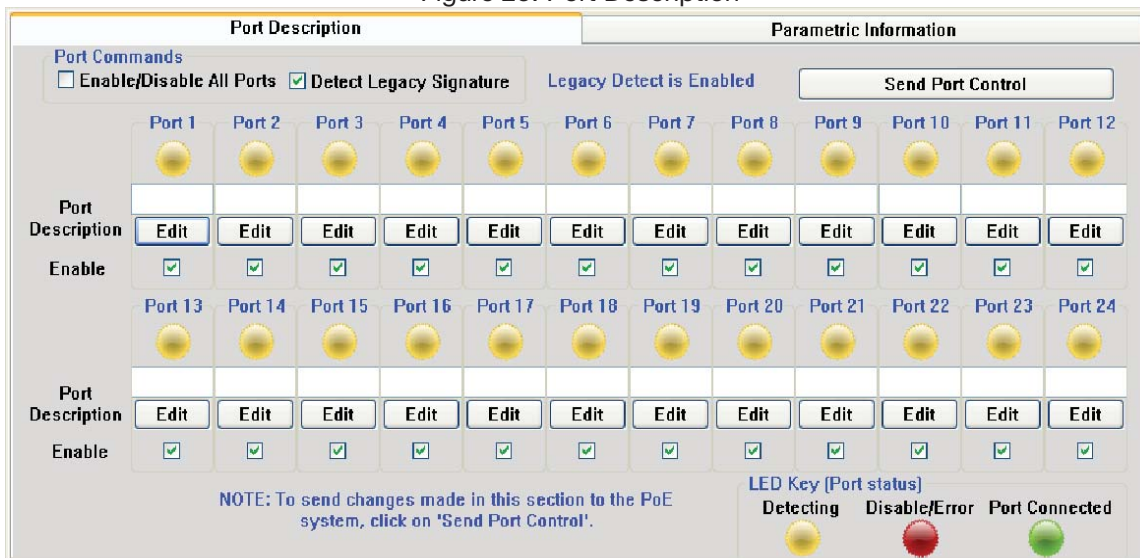

Changes to the port configuration in this section can be enacted when the user clicks the “Send Port Control” button. It will send the port information to the µP for 24-Ports. Please allow the GUI 10 seconds to refresh when this action is taken.

Port Description – Click “Edit” to edit/change the description of the port. Click “Ok” to set description on the GUI screen. If you click “Cancel”, the previous description will be set for that particular port. Click “Send Port Control” to send the descriptions to the system. To make this permanent, the user must click “Save Parameters to Flash.”

Enable – This check box can administratively enable or disable the selected port. If “Enable/Disable All Port” checkbox is selected, all ports will be enabled. Initially, the checkbox is not checked, but by default all ports are enabled. Click “Send Port Control” to send the command to the system. To make this permanent, the user must click “Save Parameters to Flash.”

If “Detect Legacy Signature” checkbox is selected, all ports are enabled and the firmware will try to detect legacy devices. By default, legacy detection is disabled. The message in blue states that the “Legacy Detect is Enabled” (Figure 16). Click “Send Port Control” to send the command to the system. To make this permanent, the user must click “Save Parameters to Flash.”



The different colored LEDs show the status of the individual ports. A 'Yellow' LED shows the port is detecting or ready to be connected. A 'Red' LED shows the port as Disable/Error. A 'Green' LED shows that the port is connected to a compliant load.

Figure 26: LED key (Port Status)





4.4 GUI Parametric Information:

This section allows users to review, but not edit, Parametric Information for each port.

Figure 27: Parametric Information

Port Description	Parametric Information											
	Port 1	Port 2	Port 3	Port 4	Port 5	Port 6	Port 7	Port 8	Port 9	Port 10	Port 11	Port 12
Discovery R	24372	131070	131070	131070	131070	131070	131070	131070	131070	131070	131070	131070
Discovery C	(uF)	(uF)	(uF)	(uF)	(uF)	(uF)	(uF)	(uF)	(uF)	(uF)	(uF)	(uF)
Current (mA)	55	0	0	0	0	0	0	0	0	0	0	0
Voltage (V)	56.0	2.9	2.9	2.9	2.8	2.8	2.9	3.0	2.7	2.8	2.7	2.8
Power (mW)	3080	0	0	0	0	0	0	0	0	0	0	0
Class Current	0	0	0	0	0	0	0	0	0	0	0	0
Determined Class	0: 33.6W	0: 33.6W	0: 33.6W	0: 33.6W	0: 33.6W	0: 33.6W	0: 33.6W	0: 33.6W	0: 15.4W	0: 15.4W	0: 15.4W	0: 15.4W
	Port 13	Port 14	Port 15	Port 16	Port 17	Port 18	Port 19	Port 20	Port 21	Port 22	Port 23	Port 24
Discovery R	131070	131070	131070	131070	131070	131070	131070	131070	131070	131070	131070	131070
Discovery C	(uF)	(uF)	(uF)	(uF)	(uF)	(uF)	(uF)	(uF)	(uF)	(uF)	(uF)	(uF)
Current (mA)	0	0	0	0	0	0	0	0	0	0	0	0
Voltage (V)	2.8	2.6	2.7	2.9	2.9	3.0	3.0	2.8	3.0	2.7	3.0	2.7
Power (mW)	0	0	0	0	0	0	0	0	0	0	0	0
Class Current	0	0	0	0	0	0	0	0	0	0	0	0
Determined Class	0: 15.4W	0: 15.4W	0: 15.4W	0: 15.4W	0: 15.4W	0: 15.4W	0: 15.4W	0: 15.4W	0: 15.4W	0: 15.4W	0: 15.4W	0: 15.4W

The Port Parametric Information panel has the following set of parameters that are displayed:

- Discovery R (ohms) – This value represents the discovered resistance (R) of the port in ohms.
- Current (mA) – This value represents the current (I) of the port in milliamps
- Voltage (V) – This value represents the voltage (V) of the port.
- Power (mW) – This value represents the power of the port in milliwatts.
- Class Current (mA) – This value represents the class current of the port in milliamps.
- Determined Class – This value represents the class of the discovered device.

Note: If the ports are less than 24-ports for the system those ports greater than the total system port count will read all zeros “0”. In the figure above, Port 1 is connected to a compliant load while Ports 2-24 are ready to be connected.



5. Troubleshooting:

If problems occur with the Midspan, verify the following:

The troubleshooting solutions provided can only solve minor problems. If your problem is not listed, please contact our Phihong Sales for further technical assistance. All up-to-date contact information can be found on our website www.phihong.com.

Table 3: Troubleshooting

Problem	Possible Solutions
Midspan does not power up	<ol style="list-style-type: none"> 1. Assure that the AC power cord is connected 2. Assure that the AC power cord is in good condition 3. If solutions 1 & 2 are true; then disconnect the AC power cord and reconnect. Observe the Port LEDs to verify a proper power up.
AC LED not lit	Verify Midspan is properly connected to an AC power source
Port LED do not light 'Green'	<ol style="list-style-type: none"> 1. Port maybe disabled and needs to be enabled using the GUI. Ensure Ports are enabled, then 'Save Flash Parameters.' 2. Assure Ports are connected to a Network
The GUI window does not update port status.	Click 'System Reset' and wait for the System to Reboot
Others. Please verify the following:	<ol style="list-style-type: none"> 1. Power is applied to the Midspan. 2. The network Ethernet cable is connected to the Data port. 3. The power device Ethernet cable is connected to the Data & Power port. 4. Proper type of Ethernet cable is used; do not use crossover-type Ethernet cable. 5. Cable pairs are connected to corresponding ports.

Appendix A: Optional RPS – option R

Please contact Phihong Sales for more information

Figure 28: DC Power Connector

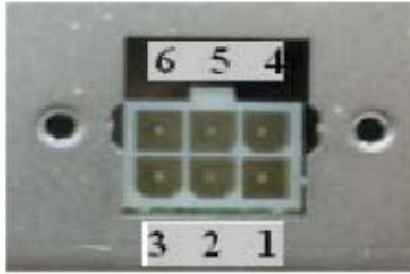

Figure 5: DC Power Connector*

Pin	Description
1	+47VDC to +57VDC
2	Current Share
3	-47VDC to -57VDC
4	+47VDC to +57VDC
5	Not Used
6	-47VDC to -57VDC

DC IN: Molex, 6 pin p/n 39-30-0060 or equivalent

DC IN Mate: Molex, 39-01-2065, pin p/n 39-00-0077

Parameters	Specifications		
DC Input Voltage Range (-R option)	47VDC to 57VDC		
DC Input Current	POE370U	POE576U	
	8.7A max	14A Max	
Output power, per port	POE370U	15.4W	
	POE576U-AT	33.6W	
	POE76U-AFAT	Ports 1-8: 33.6W / 9-24: 15.4W	
Total Output Power supported	No. of Ports		
	-8	-16	-24
POE370U	125W	250W	370W
POE576U-AT	269W	538W	N/A
POE576U-AFAT	N/A	N/A	515W

Appendix B: Optional NIC Interface – Option N

PC-to-Network-to-Midspan:

Figure 29: PC-to-Network-to-Midspan Diagram

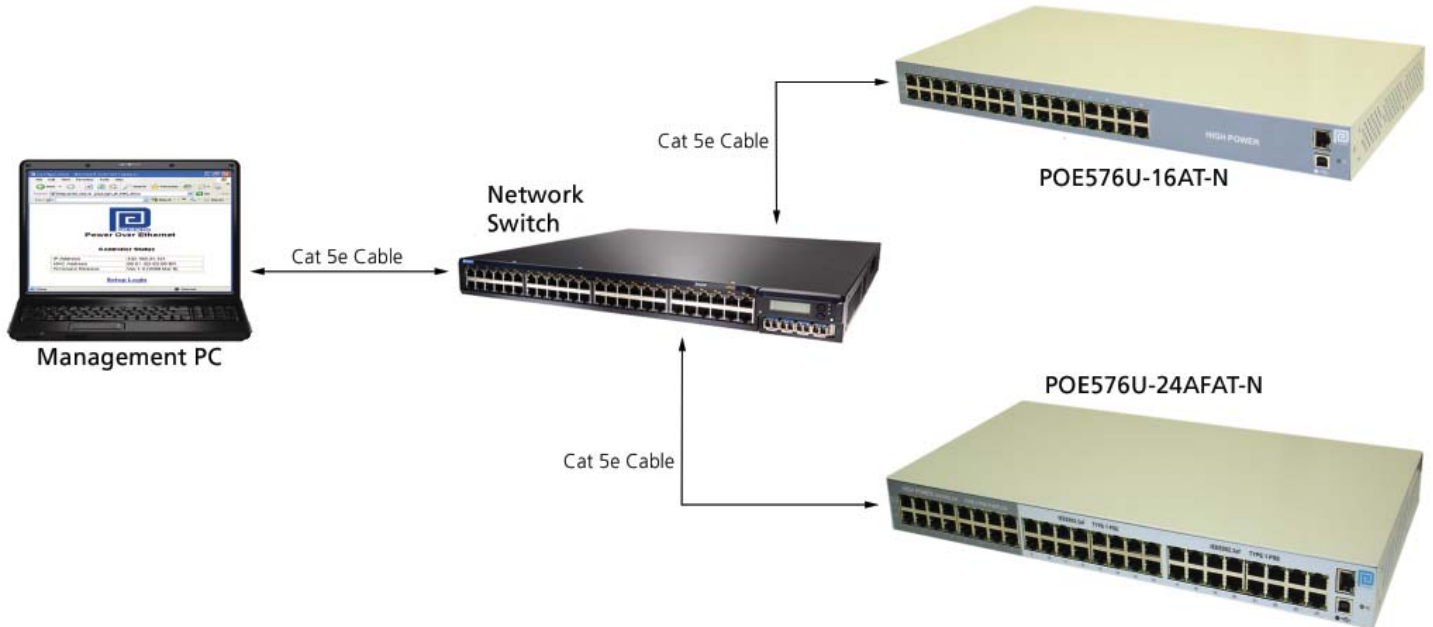

NIC Interface Setup:

NOTE: Assure the connection path between your PC and the Midspan. Skip **Step 1** if you wish to use our Phihong GUI to communicate with the Midspan.

1. Visit www.midspans.com to download the latest **SNMP MIB** for the NIC interface.

Example **SNMP MIB** file (please check our website for updates):

 phihong060809.txt 13 KB Text Document 8/9/2006 9:11 AM

If you choose to use your own SNMP console, please rename the SNMP MIB text file to the file extension that matches your SNMP Console. Follow the instructions for your SNMP Console to install the MIB file.

Please check the Phihong website (www.midspans.com) occasionally for the latest updates for the MIB and SNMP Firmware.

Example of a SNMP Firmware file (please check out website for updates):

 0608095973-b14-3.bin 58 KB BIN File 8/9/2006 9:11 AM

2. Visit www.midspans.com to download the Ethernet Manager tool (**etm.exe**). **Etm.exe** is a Device Management Utility that runs under the Windows 32 bit environment and is used to setup the IP address, subnet mask, and MAC address of your SNMP device. For more advanced setup settings, use Internet Explorer or another Internet Browser.

NOTE: Your IP Address may be different from the example shown below

3. Execute **etm.exe**  Ethernet Manager tool
4. Assuming the connection path between your PC and the Midspan is adequate; the Ethernet Manager tool will detect your SNMP device.

Figure: Ethernet Manager



5. If your device is not found, check the connection and click View » Refresh



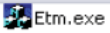
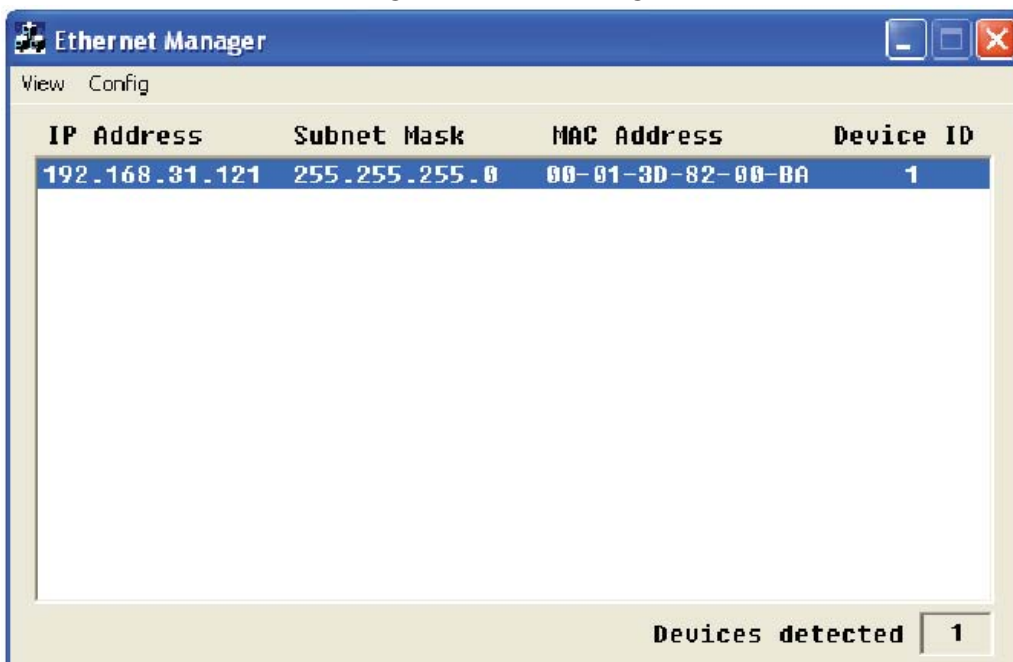
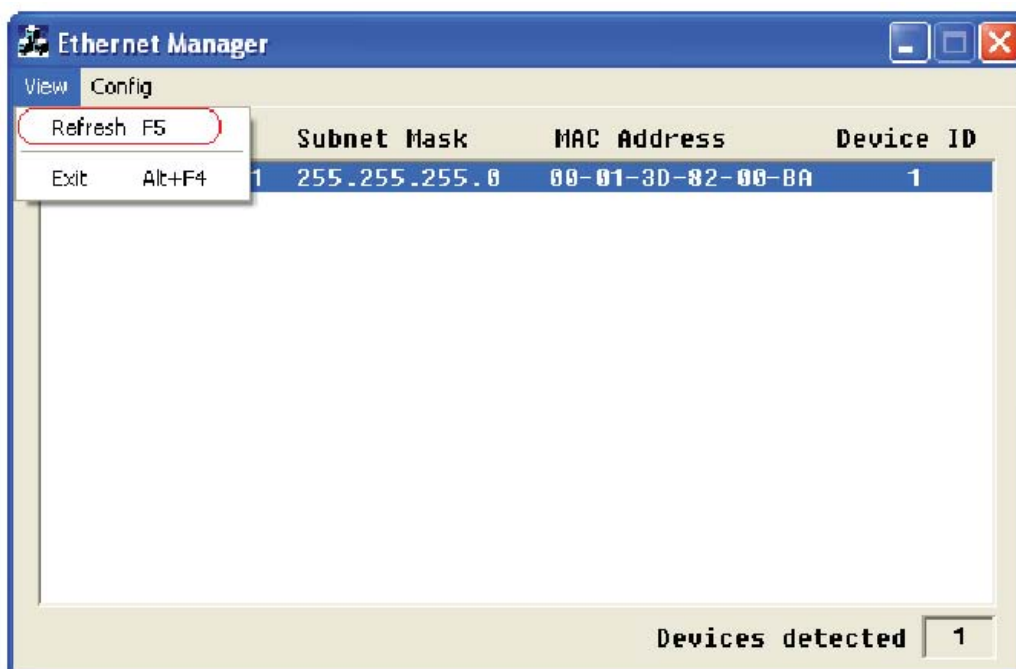

2. Advanced Setup Options

For Advanced Setup Configuration: click Config » Device Settings OR type the IP address in your Internet Browser. Your Internet Browser will open with the following window:

Figure 31: Controller Login

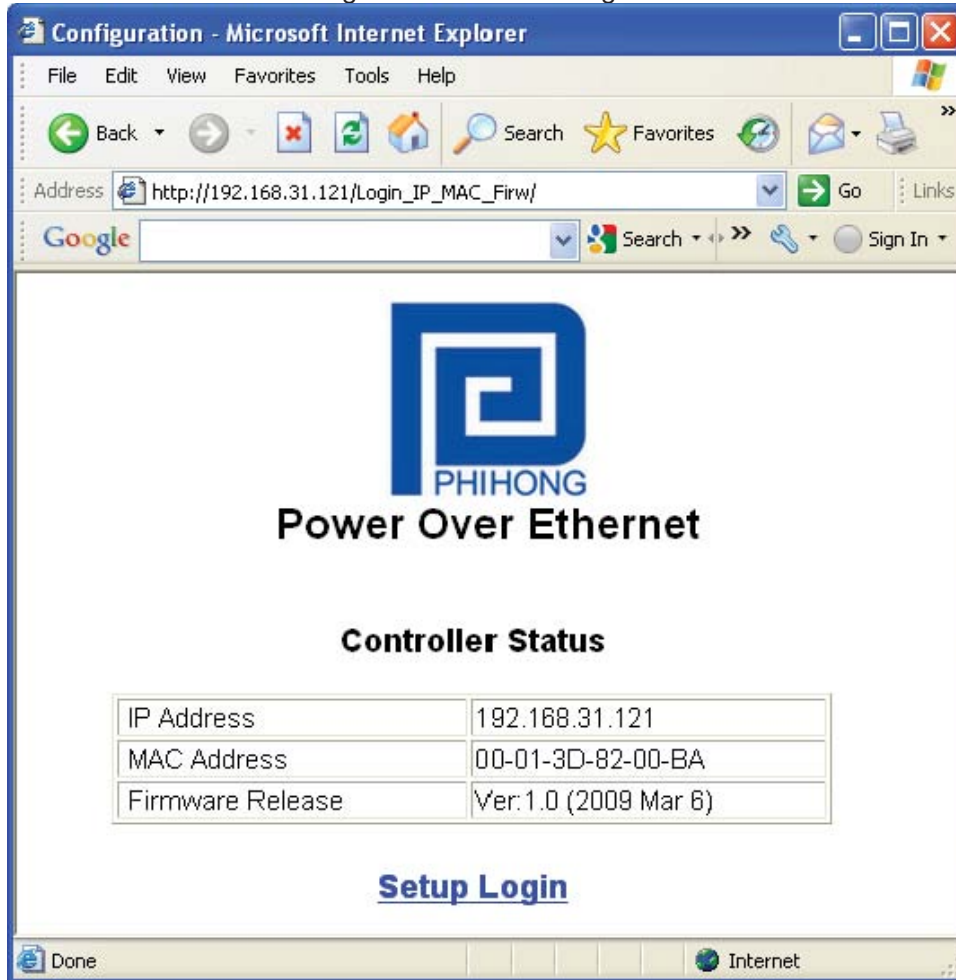

Click Setup Login
Default User: ADMIN
Default Password: (leave area blank)

NOTE: If you forget your login password, please contact Phihong Sales for further instructions. For up-to-date contact information please visit our website www.phihong.com.



3. Controller Setup

Figure 32: Controller Main Window

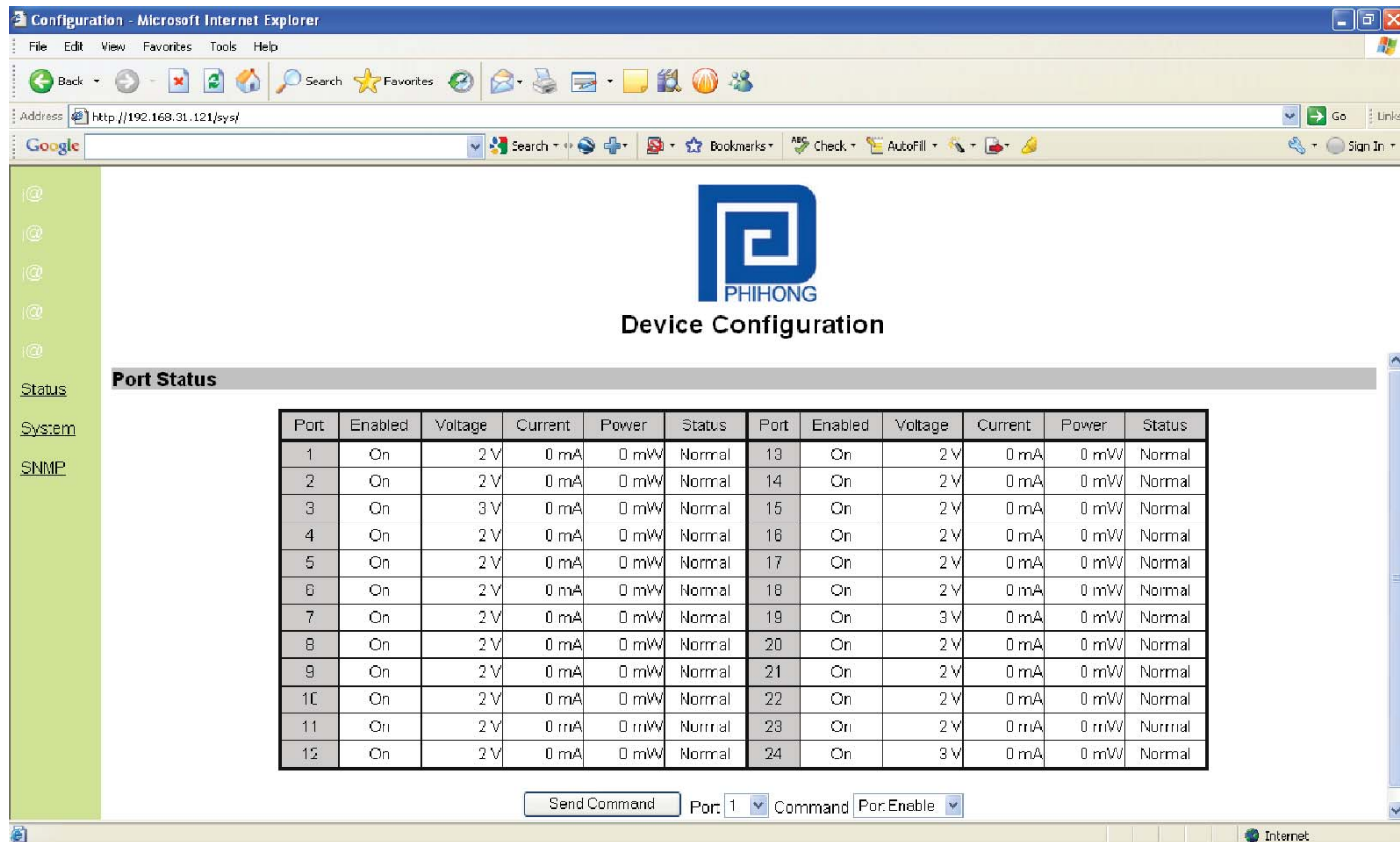

Port Status:

The main window of the controller is a simple GUI that allows the user to enable and disable midspan ports. It is also a limited display of parametric information. A more complete list of parametric information is available using Phihong's GUI software available on the website www.midspans.com.



3.1 System Administration

Figure 33: Controller System Administration

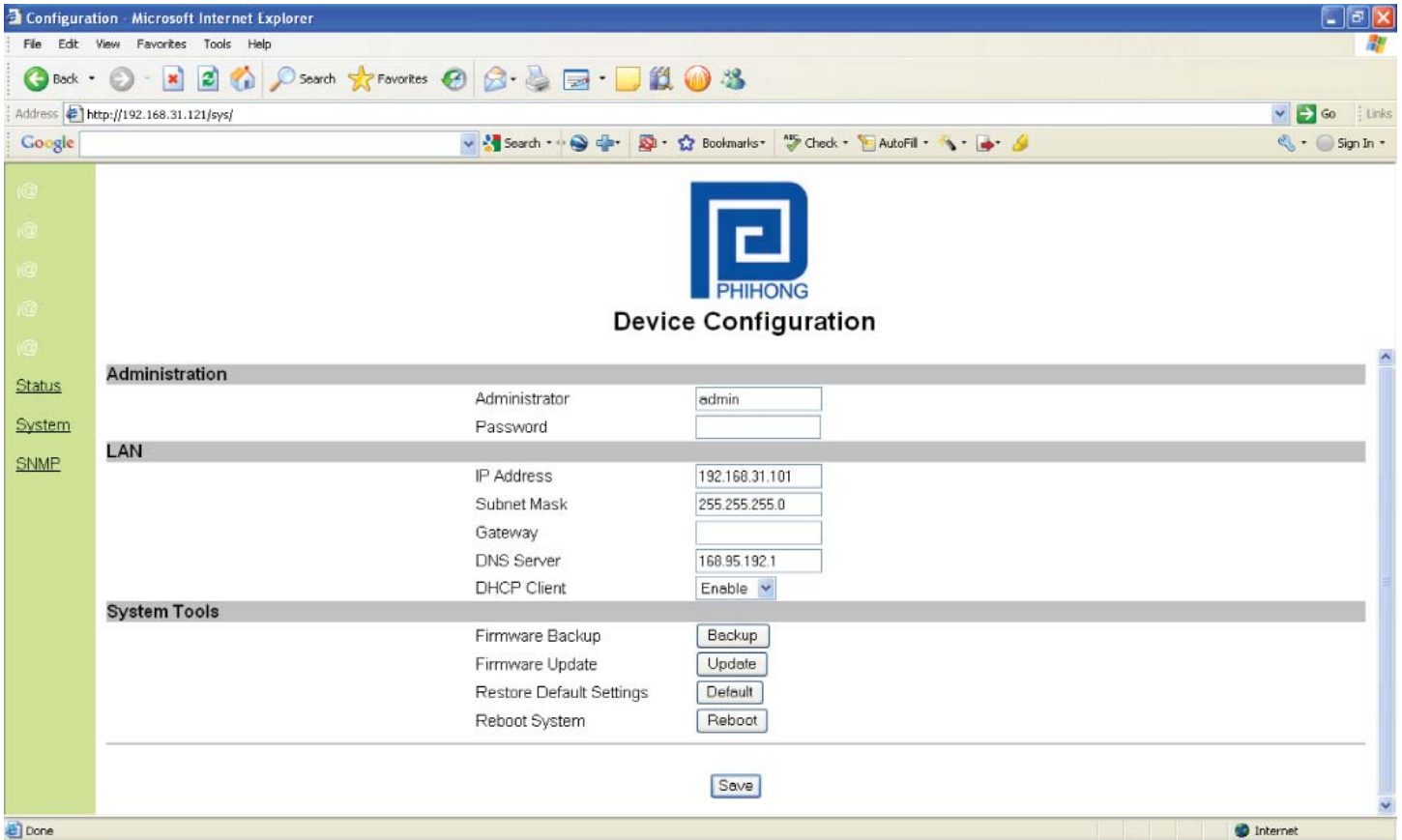



NOTE: If you change the Administrator name and password, users should ensure that it is written down in safe place for reference.

Click  to make any changes permanent.

Ok. Settings have been saved successfully



Click  to reboot the system with the new changes. This may take a few minutes depending on the connection speed. Check the Midspan IP Address again as it may have change depending on the user settings for **DHCP Client**.

Click  to review or make additional changes.



Configuration Description

Table 5: Controller Setup

Controller Setup		
	Default Settings	Description
Administrator	Admin	The login administrator is a user defined name that is used at login. Please write down your new login name in a safe location for future use.
Password	(Blank)	The login password can be empty or 1-14 characters long. Please write down your new password in a safe location for future use. The password is also used while performing SNMP Firmware updates.
IP Address	192.168.1.111	Four groups of numbers assigned by the network server (DHCP mode Enabled) or User defined (DHCP mode disabled)
Subnet mask	255.255.255.0	Four groups of numbers assigned by the Network server (DHCP mode enabled) or user defined (DHCP mode disabled)
Gateway address	192.168.0.1	Four groups of numbers assigned by the Network server (DHCP mode enabled) or user defined (DHCP mode disabled)
DNS Server	168.95.192.1	Four groups of numbers assigned to the network server
DHCP Client	Enable	<p>The default setting (Enable) sets the DHCP client in Dynamic mode. Dynamic mode allows the Network server to automatically assign the IP address, subnet mask, and Gateway address.</p> <p>If the DHCP client is set to disable the DHCP client is set to Static mode. Static mode allows the user to manually assign the IP address, subnet mask, and Gateway Address.</p> <p>Note: If the user manually assigns the IP address, the DHCP client must be set to Disable.</p>

System Tools

Firmware Backup – click the **Backup** button and you will get a pop-up to save a BIN file of the current Firmware and settings. Save in a location that will be easy for you to remember and the file may be renamed to user specifications.

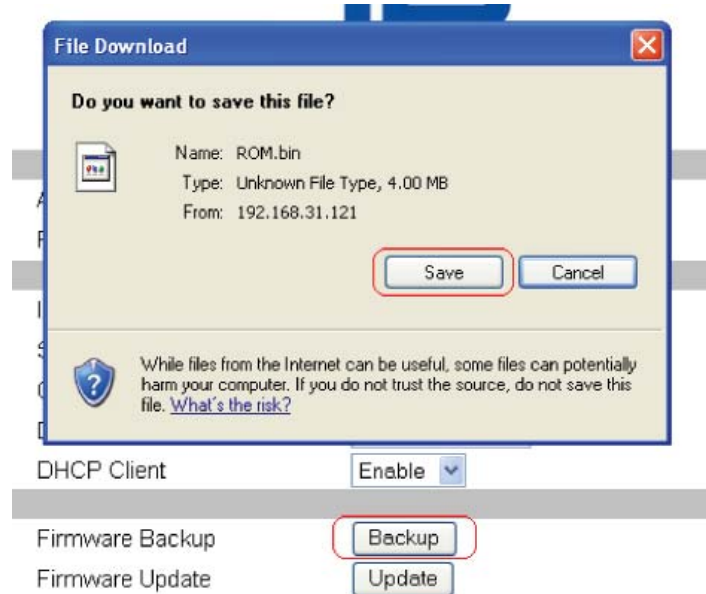
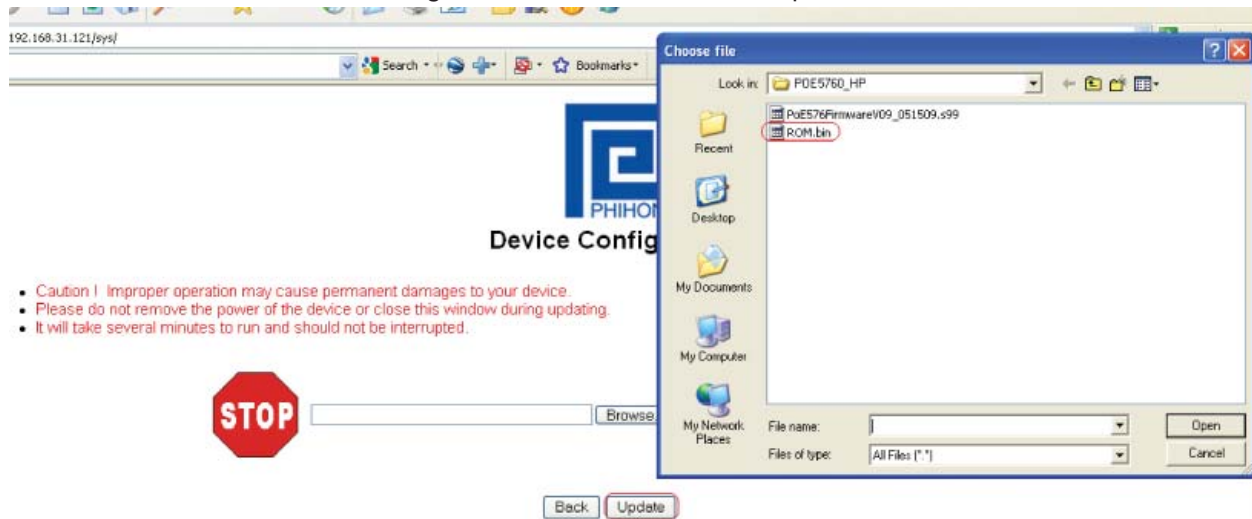

Figure 34: Controller Firmware Backup

Firmware Update – click Update to install the most recent firmware for your midspan or to re-install a firmware that was backed-up. Before proceeding with this step, users should ensure that the connection between the PC and Midspan is secure and will not be interrupted as this may take a few minutes.

Figure 35: Controller Firmware Update



Click **browse** then locate your firmware file (it will have a .bin file extension). Then click **update**.

Firmware file example:

 ROM.bin	4,096 KB	BIN File	7/29/2009 10:42 AM
---	----------	----------	--------------------



Restore Default Settings – This function is used to revert back to the default settings for the Firmware. This will undo any changes that you’ve so far made to the Firmware configuration. After using this function users will have the option to go back or to reboot their system.

Reboot System – This function will reboot the system. This screen will display:

Please wait 15 seconds while the system is rebooting !

Once the system has finished rebooting it will revert back to the GUI Main Screen.

3.2 SNMP Settings

The new SNMP v3 has added security features that were not found on previous versions of the management protocol. These include additional password protection.

Figure 36: Controller SNMP Settings

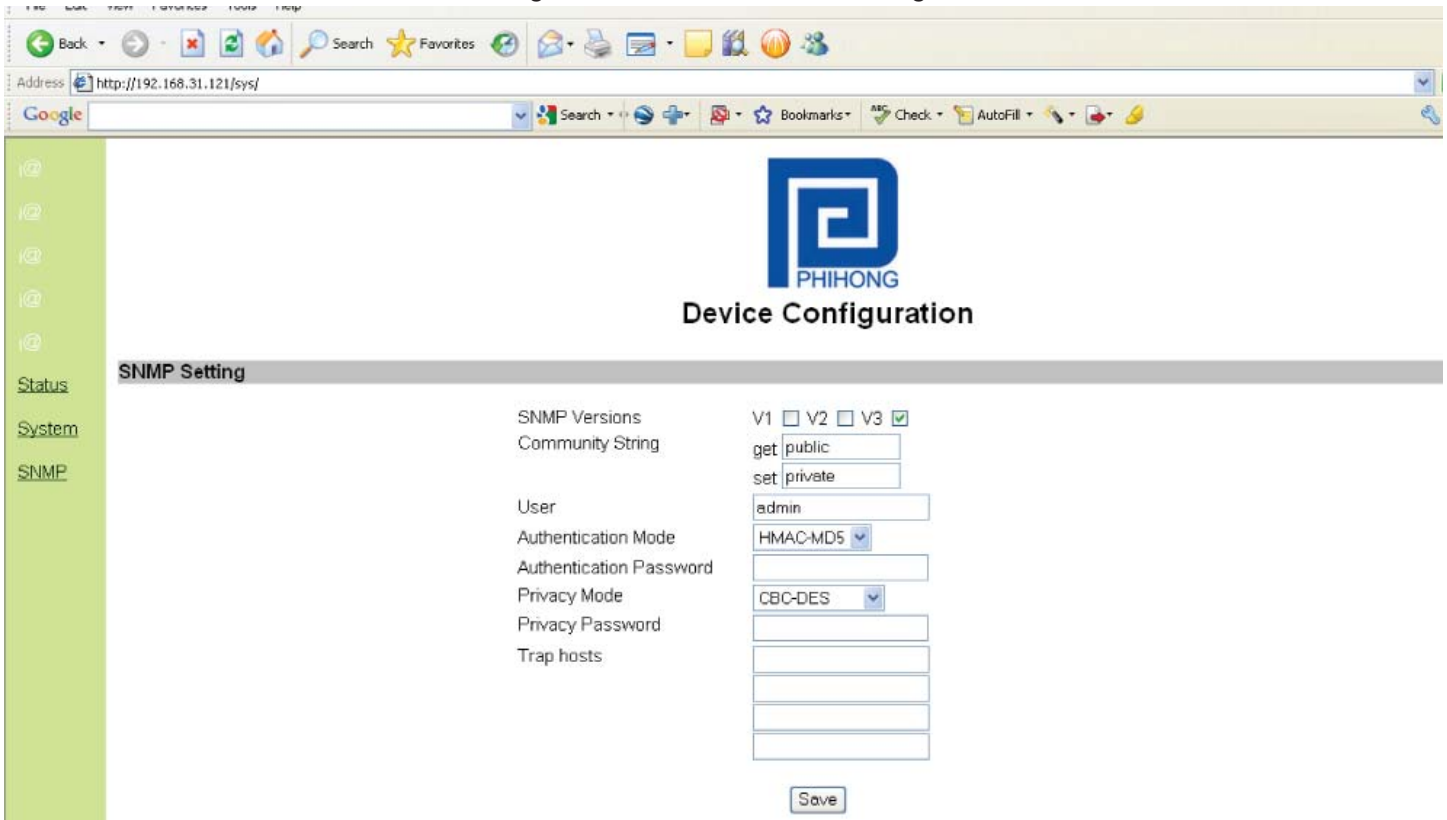

Table 6: SNMP Settings

SNMP Settings		
	Default Setting	Description
SNMP Versions	V1/V2/V3	This function describes the current version of SNMP management that the user is running. This version is V3.
Get Community String	Public	Option to set to public or private
Set Community String	Private	Option to set to public or private
User	Admin	Logon name that may be defined by the user. If changed the information should be written in a safe place for future reference
Authentication Mode	HMAC-MD5	Option to set encryption to HMAC-MD5 or HMAC-SHA1
Authentication Password	(blank)	User defined password may be left blank or 1-18 characters in length. If changed the information should be written in a safe place for future reference. This option may be used in place of the community string

Privacy Mode	CBC-DES	Option to set privacy encryption to CDC-DES or CFB-AES-128
Privacy Password	(blank)	User defined password may be left blank or 1-18 characters in length. If changed the information should be written in a safe place for future reference. This option may be used in place of the Community String.
Trap Hosts	0.0.0.0	Trap Hosts are the destination IP addresses that you want the Traps to be sent to.
	0.0.0.0	
	0.0.0.0	
	0.0.0.0	

NOTE: Trap Notifications are blocked from entering through the Windows Firewall. Please configure the Windows Firewall settings to allow incoming Network Connections, by adding a specific program (i.e. the SNMP Console).

If the user is using the Authentication and Privacy passwords, they must remember these to use the Phihong GUI. Open the Phihong GUI and locate and click **setting**.

Figure 37: GUI Connection Information

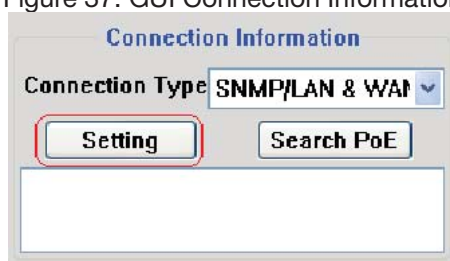

A pop-up for the **User Security Parameters** will allow you to enter the correct IP Address of your midspan. If the user is using the **Authentication** and **Privacy Passwords** ensure that **SNMPv3** is checked and enter in the correct passwords in the spaces provided. **The default passwords for both are: 12345678**. Ensure that the User also matches the name entered in the Controller Setup.

Figure 38: GUI User Security Parameters





If you wish to run your SNMP device in Static mode, you can also configure your IP Address and Subnet Mask through the Ethernet Manager tool (etm.exe).

Click Config » IP Address

NOTE: From the System Setup menu in the Controller, your DHCP Client setting must be Disable.

Figure 39: Ethernet Manager Set IP Address

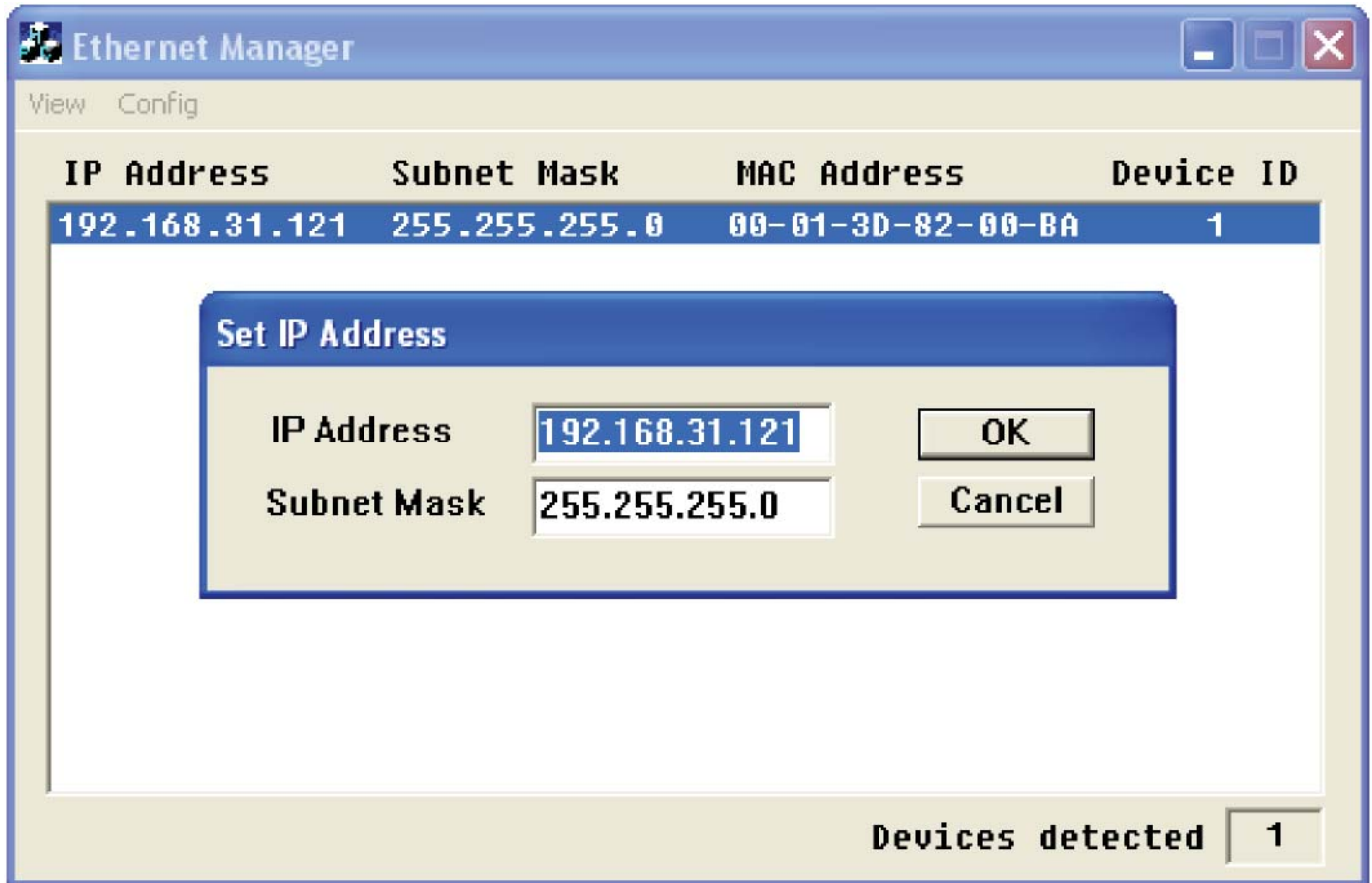

4. DHCP Client – Dynamic or Static Mode

Check your Local Area Connection Status:

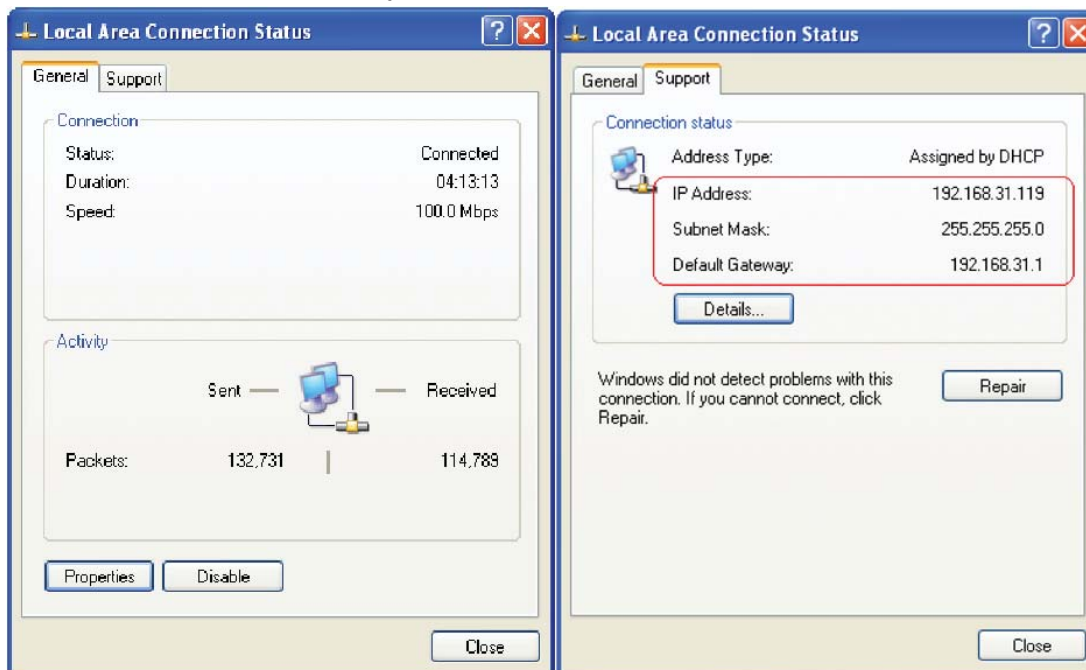
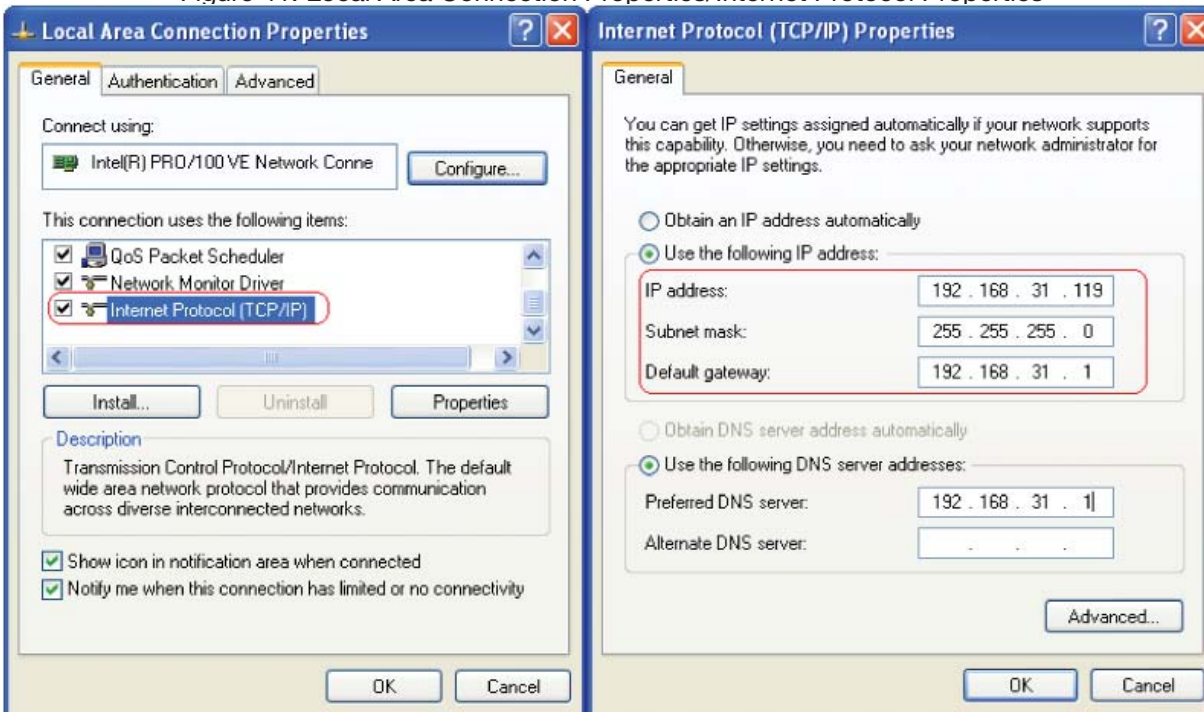

Figure 40: Local Area Connection Status

Click **Properties**. Double click Internet Protocol (TCP/IP) to view the properties. If the **DHCP Client is Disabled**, it is in Static mode. The user has the option to manually set the IP Address, Subnet mask, and Gateway Address for your PC. If the **DHCP Client is Enabled**, it is in Dynamic mode (obtain an IP address automatically). The Network will automatically set the IP Address, Subnet Mask, and Gateway Address for your PC.

Figure 41: Local Area Connection Properties/Internet Protocol Properties



5. Setup NIC Midspan with Phihong GUI

Please locate the Phihong POE GUI on your desktop or from your Start menu.

Step 1: Choose Connection Type: SNMP/LAN & WAN and click **Setting** to access User Security Parameters. Users should be aware to input the exact device IP Address.

Figure 42: GUI User Security Parameters

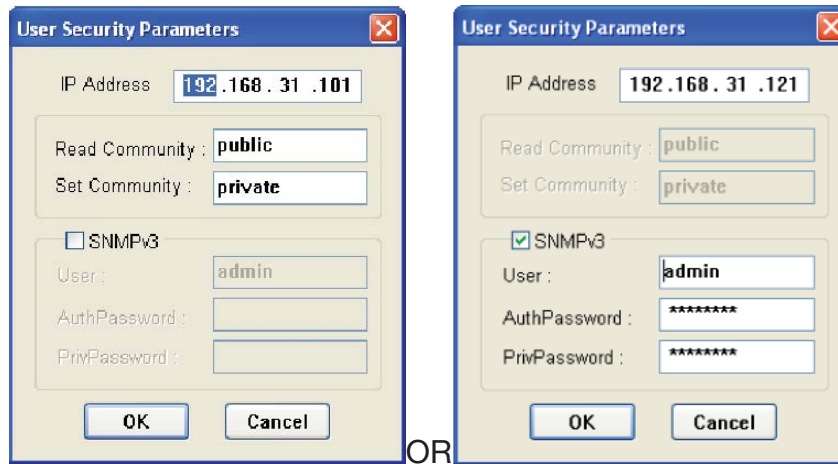

NOTE: Ensure that you are using either the community string or SNMPv3 encrypted passwords set using the Controller System setup, or the GUI will not detect the midspan. To verify the IP Address for your midspan, use the Ethernet Manager tool mentioned in earlier sections. The default password for both AuthPassword and PrivPassword is: **12345678**. Users may change these using the http:// access described in section 2 of Appendix B: Advanced Setup Options.

Figure 43: GUI User Security Parameters/Ethernet Manager

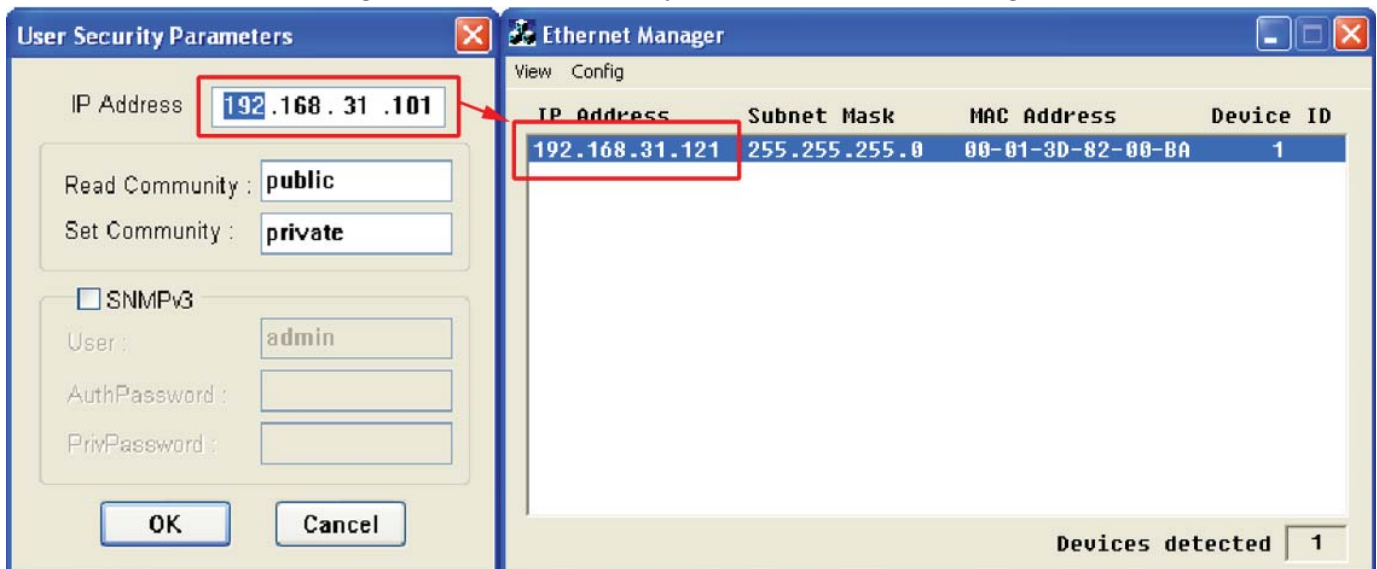



Step 2: Select **Search POE**: If Phihong POE device is found, click to select device

Figure 44: GUI Connection Information



NOTE: The IP address will be saved internally for the next use.

Figure 45: GUI Main Window

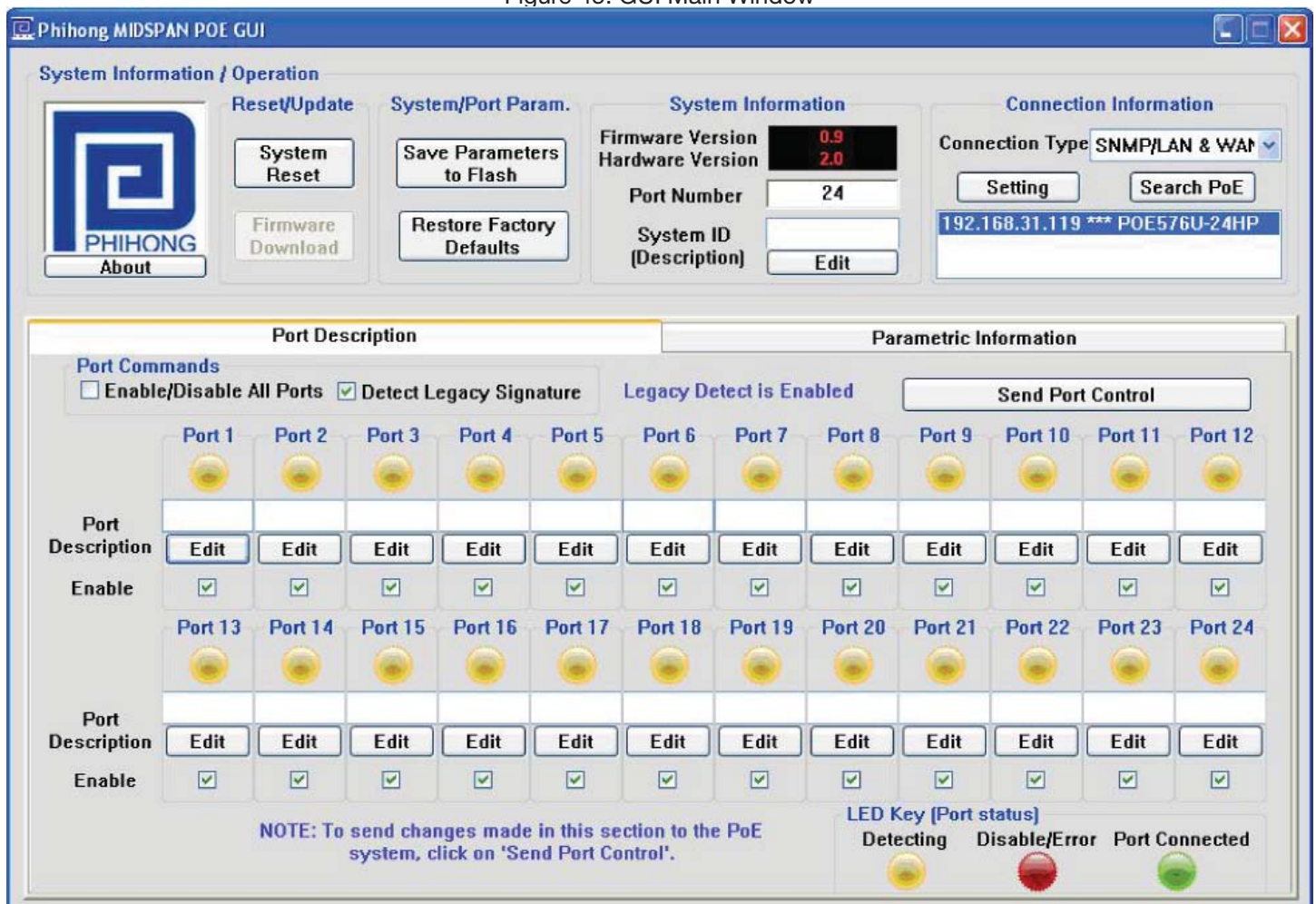

All features except for the **Firmware Download** are supported. Please refer to **section 4 – Midspan GUI** of this document for the full description of the Phihong GUI features. To update firmware using SNMP please refer to **section 7 - Controller Setup**.



Appendix C

SNMP MIB:

Phihong USA Corp. registered Enterprise ID: 1.3.6.1.4.1.24852

SNMP Version: **SNMPv3**

TCP, UDP Port: **161 SNMP** (Simple Network Management Protocol)1

Table 7 : SNMP MIB

OID	Name	Type	Value	Description
1.3.6.1.24852.2.2.1.0	poesModuleActionHubReset	INTEGER	ready (0) reset (1)	Reset the POE Controller
1.3.6.1.24852.2.2.2.0	poesModuleActionHubRestoreFactoryDefault	INTEGER	ready (0) restore (1)	Restore Factory Defaults
1.3.6.1.24852.2.2.3.0	poesModuleActionHubSaveconfiguration	INTEGER	ready (0) save (1)	Save the POE parameters to flash
1.3.6.1.24852.2.2.4.0	poesModuleAllPortPowerEnable	INTEGER	ready (0) disable (1) enable (2)	Setting this object at a value enable (2) enables detection mechanism for all ports. Setting this object at a value disable (1) disables detection mechanism for all ports
1.3.6.1.24852.2.2.6.0	poesModuleHWVersion	DisplayString	Read-Only	System hardware version for the main board
1.3.6.1.24852.2.2.7.0	poesModuleNumberOfchannel	INTEGER	Read-only	Number of ports available in the system
1.3.6.1.24852.2.2.8.0	poesModuleProductPartNumber	INTEGER	Read-only	Displays the product part number
1.3.6.1.24852.2.2.10.0	poesModuleFirmwareVersion	DisplayString	Read-only	System firmware version for the PoE
1.3.6.1.24852.2.2.11.0	poesModuleDescription	DisplayString (SIZE (0...10))	Read-Write	System Description, max. length of 10 characters
1.3.6.1.24852.2.2.12.0	poesModuleConsumptionPower***	INTEGER	Read-only	Measured power usage expressed in Watts
1.3.6.1.24852.2.2.13.0	poesModulecontrolACPower***	INTEGER	Read-Write	Sets the value of available power in Watts to be supplied by primary (AC) power source
1.3.6.1.24852.2.2.14.0	poesModuleControlDCPower	INTEGER	Read-Write	Sets the value of available power in watts to be supplied by secondary (DC) power supply



1.3.6.1.24852.2.2.15.0	poeSystemControlBothPower***	INTEGER	Read-Write	Sets teh value of the roral available power in Watts to be supplied by both power sources
1.3.6.1.24852.2.3.1.1.1~24	poePortIndex	INTEGER	Read-only	A unique value for each port.
1.3.6.1.24852.2.3.1.2.1~24	poePortPowerEnable	INTEGER (1.2147483647)	Disable (1) Enable (2)	Setting this object at a value enable (2) enables the detection mechanism for htis port. Setting this object at a value disable (1) disables the detection mechanism for this port
1.3.6.1.24852.2.3.1.3.1~24	poePortControlMaxPower***	INTEGER	Read-Write	This command specifies the max. power in watts to the port
.6.1.4.1.24852.2.3.1.4.1.0	poePortCurrentStatus***	INTEGER	undercurrent (1) overcurrent (2) both (3) ok (4)	Describes a current port status related to the power generation, the value undercurrent (1) indicated that the port current is below the minimal value since the attribute was last cleared. The value over current (2) indicates that the port exceeds the maximum value since the attribute was last cleared. The value both (3) indicates that both undercurrent and over current since the attribute was last cleared. The value ok (4) indicates neither an undercurrent or an overcurrent condition has been detected since the attribute was last cleared. This attribute is cleared through the power-Portcurrentstatus-Clear Action.



1.3.6.1.4.1.24852.2.3.1.5.0	poePortCurrentStatusclear***	INTEGER	off (1) clear (2)	Setting the value of this object to clear (2) clears the value of the poePortStatus and enables the agent to update the poePortStatus. During Read operation this value will be off (1)
1.3.6.1.4.1.24851.1.2.1.6.1~24	porPortDescription	DisplayString (SIZE (0...10))	Read-Write	Describes the port descriptionfor the port
1.3.6.1.4.1.24852.2.3.1.7.1~24	poePortDetectionStatus***	INTEGER	Read-only	Off (0) DiscR (1) DiscC (3) RampUp (4) RampDown (5) SampleI (8) SampleV (9)
1.3.6.1.4.1.24852.2.3.1.8.1~24	poePortPowerClassifications***	INTEGER	Read-only	Class0 (1) Class1 (2) Class2 (3) Class3 (4) Class4 (5)
1.3.6.1.4.1.24852.2.3.1.9.1~24	poePortPowerDetectionControl***	INTEGER	Read-Write	Command controls the port power detection control
1.3.6.1.4.1.24852.2.3.1.10.1~24	powPortPowerPriority***	INTEGER	Critical (1) High(2) Low (3)	Sets port priority
1.3.6.1.4.1.24852.2.3.1.11.1~24	powerPortPower	INTEGER	Read-only	Port Power reading in mWatts
1.3.6.1.4.1.24852.2.3.1.12.1~24	poePortVoltage	INTEGER	Read-only	Port Voltage reading in Volts
1.3.6.1.4.1.24852.2.3.1.13.1~24	poePortCurrent	INTEGER	Read-only	Port Current reading in mAmps
1.3.6.1.4.1.24852.2.3.1.14.1~24	poePortResistance	INTEGER	Read-only	Port Resistance read in Ohm
1.3.6.1.4.1.24852.2.4.1.1.1~24	poeTrapsControlGroupIndex	INTEGER (0.65535)	Not-accessible	Uniquely describes the group the Trap control is located
1.3.6.1.4.1.24852.2.4.1.2.1~24	poeTrapsControlEnable	INTEGER	TrapsDisabled (1) TrapsEnabled (2)	Enables and disables the Trap from the Agent
1.3.6.1.4.1.24852.2.5.1	poePortHWFailTrap	NOTIFICATION		Hardware Failure Trap
1.3.6.1.4.1.24852.2.5.2	poePortPeakOverCurrentTrap	NOTIFICATION		Peak over Current Trap



1.3.6.1.4.1.24852.2.5.3	poePortOverloadTrap	NOTIFICATION		Overload Trap
1.3.6.1.4.1.24852.2.5.4	poePortDiscoveryFailTrap	NOTIFICATION		Discovery Failure Trap
1.3.6.1.4.1.24852.2.5.6	poePortDisconnectTrap	NOTIFICATION		PortDisconnectTrap
1.3.6.1.4.1.24852.2.5.7	poePortVoltageFailTrap	NOTIFICATION		Port Voltage Fail Trap

*** This function is currently disabled. Reserved for future use.

- 1 The NIC Interface Midspan performs under the TCP/IP, UDP port of 161. UDP port 161 for SNMP is an official IANA registered EDP port number. While attempting to connect to the NIC Interface Midspan via a different network domain² the user must acknowledge that the local network supports the UDP port 161.

2. Different Network Domain

Figure 46: Network Domain Diagram

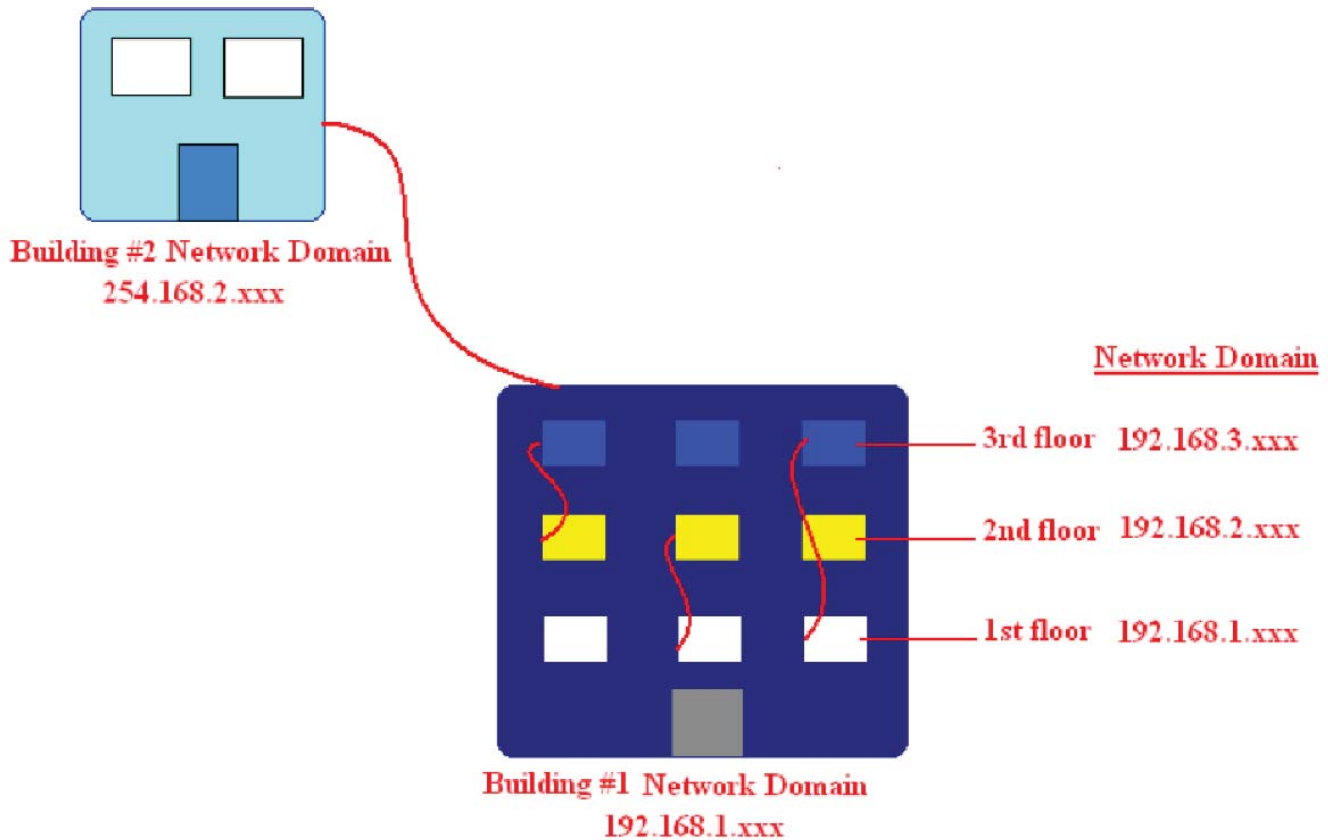

Description of Diagram:

- Building #1 has on main Network Server that links all three floors together.
- Building #2 has one main Network Server with the Network Domain of 254.168.2.xxx.

Different methods of connection:

NOTE: Taking consideration that the Access Control from the Controller Setup is Disabled (allowing all access)

- **Connection within the same Network Domain.** (Please refer to the diagram above for Building #1. For instance:
 - The NIC Interface Midspan is connected to the Network Domain of 192.169.1.xxx located on the 1st floor. All Computer connected to the Network Domain of 192.168.1.xxx can communicate with the NIC Interface Midspan.
 - The NIC Interface Midspan remains connected on the Network Domain of 192.168.1.xxx. Since Building 1 has a main Network Server that links all three floors together, the computers on the 2nd (192.168.2.xxx) and 3rd (192.168.3.xxx) floors can also communicate with the NIC Interface Midspan.



- **Connection between different Network Domains.** (Please refer to the diagram above Building #2)
For instance:
 - The NIC Interface Midspan is connected to the Network Domain of Building #1 (192.168.1.xxx) would like to communicate with the NIC Interface Midspan from Building #1. Building #1 must configure the main Network server to allow access from an outside source, in this case Building #2. Building #1 must be able to support UDP port 161, for SNMP. Once the access is allowed, Building #2 can communicate with the NIC Interface Midspan.



Appendix D: Frequently Asked Questions

Q: What happens if I forget my username and passwords for the NIC Interface?

A: Please contact Phihong Sales for further information on this topic.

Q: What is the function of the “current share” pin on the CD Power connector? Are there any protocols or procedures associated with it?

A: The DC solution contains 3x 500W 50V rectifier modules (1000W N+1) with custom cables available for connection between the rectifier rack and up to 4 midspans. The current share pin is an option which could be used to have the power supply inside the midspan current share with the rectifiers. There are no protocols or procedures associated with it other than it's designed only to work with our rectifier system and even then its not perfect sharing due to the inrush limiting components inside the midspan located on the DC input.

Q: What type of Display Properties settings are required to run the Phihong SMNP v3 GUI?

A: 16-Bit: 1024 X 768 pixels, 1280 X 1024 pixels
32-Bit: 1024 X 768 pixels, 1280 X 1024 pixels

If the settings are set to be at least the values shown below, the edges of the GUI window will be cropped.

16-Bit: 640 X 480 pixels, 800 X 600 pixels
32-Bit: 640 X 480 pixels, 800 X 600 pixels